



Overlander Handbook

Planning, preparation and execution of a world trip

Ueli Leardi

Text and cover layout: © Copyright by Ueli Leardi

Proof reading: Phil Stoor, UK

Pictures if not otherwise mentioned: Ueli Leardi; underway.ch

Contact: via website www.underway.ch

Version V2.2 EN February 2024

In general, it cannot be guaranteed that the information contained in this book is up-to-date, correct and complete. Suggestions for additions and improvements are expressly desired. Contact via website www.underway.ch

Products and information recommended, mentioned or linked in the book have no commercial reference to the author and nor does he receive any credits or other privileges for it. Most of them have proven themselves as part of his equipment or have been recommended by other travellers.

Overlander Handbook

Content

Preface.....	1
Introduction	2
When Should You Start?	16
Which Travel Style Suits Me?	19
Travelling with Children	20
Travelling with Pets.....	22
Financing the Trip.....	25
Planning.....	28
Every Beginning is Difficult	28
Financial Plan.....	28
Route Planning	35
Best Travel Season Respectively Start Time	36
Vehicle procurement.....	42
Basic Considerations.....	43
Residential Section of the Vehicle	44
Sleeping	44
Water Supply	51
Toilet Systems	57
Electrical System.....	60
Cabin Design.....	70
Base Vehicle	74
Base Model	75

Preparation.....	84
Vehicle	84
Vehicle Equipment.....	85
Camping Equipment	96
Photo- und Video Equipment	102
Computer Equipment.....	107
Mobile Phone and Internet	109
Software Tools	116
Building a Website	124
Social Media.....	127
Insurances	127
Preventive Healthcare	132
Test Journey	136
Documents	136
Finances	142
Flight Tickets.....	152
Mail	153
Terminations.....	154
Underway.....	155
Obtaining Travel Information	155
Withdraw Cash.....	156
Paying with Creditcards	157
Photography and Filming.....	158
Navigation.....	160
Search for places to stay	162
Cooking and Baking	164

Drinking and Waste Water	166
Vehicle Maintenance.....	167
Bordercrossings	168
Temporary Import of the Vehicle	171
Telephony and Internet.....	173
Police and Military Check-Points	173
Getting additional Visas and Permits	174
Organizing Vehicle Shipping	175
Safety.....	176
Sources and Links	185
Information and Websites.....	185
Specialist Forums and general Information Sources.....	186
Shipping	188
Documents	189
Travel and Vehicle Insurance.....	189
Finances	190
Internet and Telephone	190
Helpful apps	191
Safety.....	193
Health	194
Vehicle Build and Equipment	194
Other Books and Games of the Author.....	194



Preface

Actually, it is presumptuous to do justice to this great topic with just a single book. Travel, with all its possibilities, is so complex that it is difficult to present all aspects and facts in one work.

The book is aimed at people who dream of a long journey. It offers support to manage the planning, preparation and implementation as successfully and structured as possible. Most of the content is based on the author's personal travel experience. He has already been on the road several times as an "Overlander". All in all, in addition to the many short trips, he can look back on more than 5 years of long-term travel. In terms of content, it deals in detail with what, from the author's point of view, encompasses classic "overlanding", namely:

Travelling in your own, largely self-sufficient motor vehicle for a period of several months to years and that also in regions where organized mass tourism has not yet gained a foothold and the tourist infrastructure is still underdeveloped.

The logic of the book is structured in such a way that it makes sense to approach the "project" trip around the world without creating too many dead ends in the process. At the same time, most travel-related aspects are taken into account. Some links and information are explicitly only relevant for certain target groups, for example people with Swiss or European affiliation, and wherever available, refer to English-language texts and pages. Other interested parties should also find out more about the relevant topic on the Internet.

Introduction



Introduction

This chapter provides food for thought in order to create the basis for detailed planning, preparation and implementation of a major trip. This is where the decision is made as to how long and where travellers want to go or with what vehicle they want to travel with.

To Where Should the Trip Lead?

There are some classics among the many possible travel routes, which are briefly portrayed below. Which option is chosen primarily depends on personal interests, the time at disposal, the vehicle used and the available budget. Some routes can be combined, as many around the world travellers do.

Panamericana

The Panamericana Route is considered to be the longest route in the world, even though it is not continuously navigable between Panama and Colombia. The official route layout is controversial, thus different variants are circulating. In the south of the island of Chiloé in Quellón, for example, a monument commemorates the southern end of the Panamericana. However, it is also said to lead from Anchorage, Alaska to there and to be 22,000 km long. Other sources see the route from the northernmost point of the double



Figure 1 End of the Panamericana in Quellon (underway.ch)

Introduction

continent, it lies on Prudhoe Bay, leading to Ushuaia in southern Patagonia. According to Google Maps, however, this route “only” adds up to 22,000 km too. Either way, travellers will hardly stick to the direct route, as there are only a few places worth seeing and only little interesting landscapes along this main transit route. Highlights are rarely along this fast connecting route, sometimes even far away. It is therefore not surprising that the travelled route stretches normally over a multiple of this, not least because for Europeans the ports of arrival and return are thousands of kilometres away from the start and finish of the "Panam".



Figure 2 Iguazu waterfalls ([underway.ch](#))

The route from Alaska to Tierra del Fuego, or in the opposite direction, is very popular, not least because it can be undertaken without any major formalities and not even a specially equipped vehicle is needed. Another advantage is that communication with the local population on

almost the entire two semi-continent is possible using only two languages, namely English and Spanish.

This is important, because knowledge of foreign languages is not very widespread among the local population in either North or Latin America.

Are there any special arguments for travelling from north to south or in the opposite direction? Yes, if you start in North America, you have the following advantages: in the first few months of travel the trip takes place in a largely known social system for travellers from Europe or generally from western-oriented countries and cultural environ-

Introduction

ment. Of course, there will still be many new and different encounters to deal with, but the lifestyle and social customs are still similar. In addition, the two most expensive countries, the USA and Canada, are visited at the beginning of the trip, when the budget has not yet been stretched and therefore allows more leeway.

The start of a trip in South America is actually only advised if the start of the trip must or should be between October and February. Then winter prevails in North America while spring or summer arrives on the South American continent.

Since the road between Panama and Colombia is not continuous, it will be necessary to ship the vehicle around the Darien Gap. This is usually organized between Colon in Panama and Cartagena in Colombia. Since right-hand drive vehicles are not allowed to enter Nicaragua and Costa Rica, these cars are usually shipped from and to Veracruz in Mexico. Depending on the size of the vehicle, sea transport is anyway a significant cost factor.

Many travellers from Europe start on the



Figure 3 Route of the Panamerican Hyw Created by en:User:Seaweege
Copyrighted free use, <https://commons.wikimedia.org/w/index.php?curid=150379>

Introduction

east coast of North America and drive from there to northern Alaska to begin the long journey south. For this variant, the start should best be placed in spring.

Overall, the route is very varied and offers many highlights for all interests:

- The vast and untouched regions of the extreme north and south
- The countless and unique national parks along the route
- Indigenous cultures from Alaska to Mexico to South America
- A very diverse flora and fauna
- Climate zones from arctic to tropical
- Altitudes from below to over 5000 metres above sea level
- Interesting cuisine, especially in Latin America
- Latino hospitality and lifestyle

Most travellers take around two years to complete this route. This period will allow taking appropriate detours in remote and interesting regions. A total of around 70,000 to 100,000 km must be expected. The average monthly costs are between \$ 1500 (Mexico) and \$ 3000 (USA), (cost basis: camping, mostly self-sufficient, <3.5t vehicle with two people). The vehicle shipping and flights to and from America must be added on top. Please note the additional information in the [budget chapter](#). With the exception of the USA, no visa is required for most nationals in any other country and even for the USA it is only required if the visit is to last for more than 90 days after first entry to the country. No CdP (Carnet de Passage) is required for the vehicle.

Trans Africa

For travellers from European countries, the Trans Africa routes have the great advantage that they can start from their own doorsteps without time-consuming and costly shipping. Basically, it must be decided whether the west or the east route should be travelled. For a long time now, it has hardly been possible to cross the central Sahara for safety reasons. But the other two variants also harbour risks and often unpredictable difficulties. In the southern part of the continent there are dif-

Introduction

ferent options for both variants to extend the trip and deviate from the direct route.

The western route includes some countries where prior information about the current safety situation is essential. Since there are also many small countries on this route, there are correspondingly high visa costs and time-consuming border crossings.

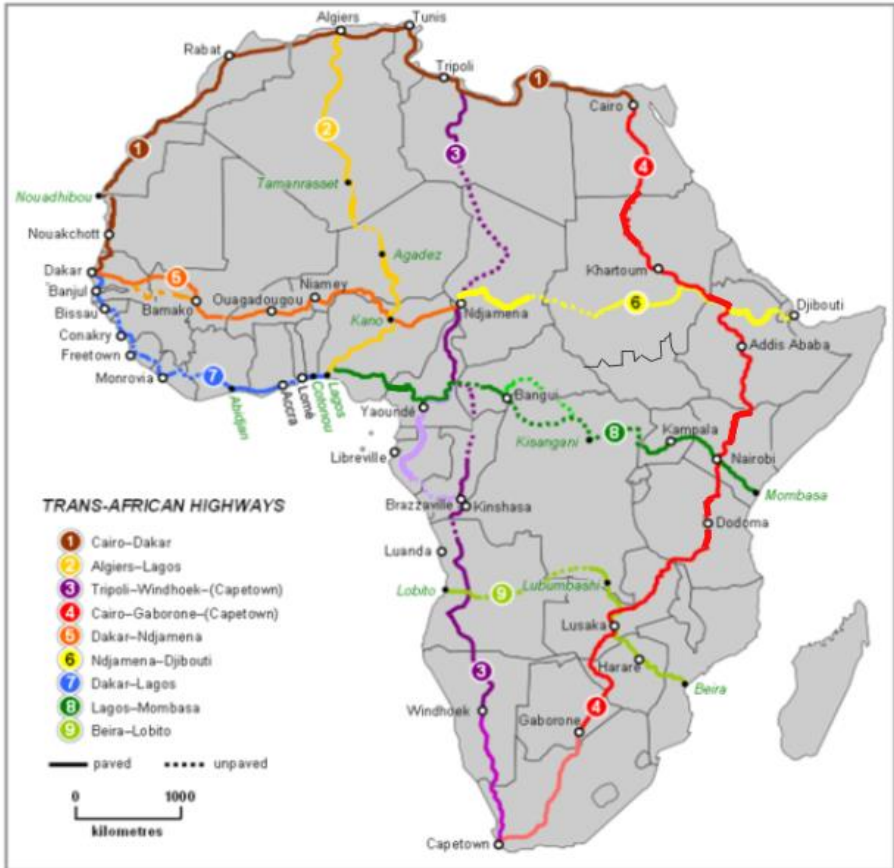

Figure 4 Various Trans Africa routes

Von I, Rexparry sydney, CC BY-SA 3.0, <https://commons.wikimedia.org/w/index.php?curid=2427121>

The eastern route can be started via Egypt and nowadays also via Saudi Arabia. You have to ship to Egypt, as the land routes to this country are currently neither accessible from the west nor from the east (2024). Entry with your own vehicle is time-consuming and expensive, but is

Introduction

especially worthwhile if Egypt is planned as a country of particular interest.

Even if Saudi Arabia is now quite easy to travel to, the route to get there is also uncertain because of the war in Syria and right hand drive vehicles are not permitted in Saudi Arabia!

Another possibility is to ship the vehicle directly to Mombasa, East Africa in order to avoid the trouble spots of Sudan and Ethiopia.

Both routes offer a lot of variety:

- The deserts in the north and south of the continent
- The joy of life of Africans
- Incredible wildlife in the game reserves and national parks
- Impressive landscapes

The route is certainly demanding in terms of organization and planning, as it is important, among other things, to obtain the required visas in advance, but also along the trip. Depending on the route, a CdP ([Carnet de Passage](#)) for the vehicle is required or at least advantageous.



Figure 5 Boabab tree in Botsuana ([underway.ch](#))

A simple, fairly direct north-south route without major detours and deviations can be done in half a year, but at least a year should be planned in order to have enough time to get to know the countries south of the equator better. It is important to choose the right season, as traveling the unpaved roads

can become a challenge, especially in regions with a pronounced rainy season, or where very hot temperatures can prevail in areas in the summer months. It is advantageous to travel this continent in an off-

Introduction

road vehicle. This enables you to go on wildlife safaris independently in many national parks, among other adventurous route options. Trucks with more than 3.5 t are not permitted in many national parks!

Knowledge of French and English is sufficient to communicate in many African countries, except of course off the beaten path, where communication can only be done by hand and foot. In most African



Figure 6 Bush camp in Mauretania ([underway.ch](http://www.underway.ch))

countries, the cost of living is much cheaper than in western countries. However, the expensive admissions and camping prices in the game reserves and national parks and the sometimes high visa costs have an impact on the budget. De-

pending on the route, it is advisable to obtain a Carnet de Passage; via Egypt and if the vehicle is shipped in this is mandatory anyway. If the journey, once in South Africa, does not lead back overland, the return shipment and the flight home must also be budgeted.

Silk Road

The classic Silk Road leads from the Middle East to China. Travel routes, even if they are based on the Silk Road, follow the ancient route only partially and can include any number of variants and detours. A common route is the journey via the Balkans to Turkey and then through Iran and the Stan countries to China.

Afterwards, the journey can lead back to Europe through Mongolia and via Russia, or further to Southeast Asia.

Introduction



Figure 7 *Variants of the antique Silk Road* From *Silk_Road_in_the_1_century_AD_-_ru.svg*; Kaidorthis file: Furfur - This file has been derived from: *Silk Road in the 1 century AD - ru.svg*, CC BY-SA 4.0, <https://commons.wikimedia.org/w/index.php?curid=77678036>

High lights:

- Most countries are still not burdened by mass-tourism
- Old cultures can still be experienced up close
- The typical hospitality of the residents
- Enormous mountain landscapes
- Architectural jewels along the Silk Road

When determining the start date of the journey, the schedule should be coordinated with the climatic conditions. Some regions along the route only have short time windows in which the travel conditions are optimal. Either the journey leads east in a single season or a very slow pace is chosen in order to avoid unfavourable climatic conditions. The route via Turkey, Iran and further through the Stan countries to China largely follows the Silk Road. Time-consuming formalities and an expensive guide are necessary to cross China. If a small group organizes itself, you can share and reduce the costs.

All countries along the Silk Road belong to the low-cost regions and the visa fees are also affordable, as more and more countries are doing

Introduction



Figure 8 Cappadocia, Turkey ([underway.ch](http://www.underway.ch))

without them entirely. If you do not travel further in the east or if you do not decide to take a round trip back to Europe, an expensive return transport is required in the end. Therefore it is usually avoided.

A CdP is usually required for the vehicle because Iran, along with a few other Asian countries, requires it. Linguistically speaking, knowledge of Russian, which is often spoken in the Stan countries and in Russia itself, is most likely to help. Otherwise, a variety of "exotic" languages, at least from the point of view of people with a Western language background, is the rule.

Australia

You have to consider carefully whether your own vehicle should be shipped to Australia or not. Shipping there and back is quite expensive, and the quarantine requirements are quite restrictive, i.e. the car has to arrive almost clinically clean, otherwise there is a risk of delays and / or high cleaning costs at the port of arrival.



Figure 9 Crossing the Simpson Desert ([underway.ch](http://www.underway.ch))

If you don't own a touring vehicle yet, Australia offers a large used vehicle market for 4x4s and campers as well. If you also plan to visit the remote regions of Australia, you will have to choose a 4x4 as a

Introduction

travel vehicle, the outback tracks are most often only accessible to well-equipped off-road vehicles.

Somewhere in Australia is always the "best travel season". This means that the start of the journey can take place at any time of the year, yet the start location must be carefully selected.

Basically, Australia can be divided into optimal travel periods as follows:

Region	Best travel time
Outback and north	Winter to spring (May - Oct)
Southern West Australia	Spring (Aug-Nov)
South Coast (Adelaide to Brisbane)	Spring to Autumn (Aug-June)
Snowy Mtns., Southern beaches	Summer (Nov - March)
Tasmania	Summer (Dec-Feb)

ATTENTION:

The seasons in the southern hemisphere are shifted compared to the northern by 6 months and the summer rainy season in the north can never be reliably foreseen!

The main school holiday time in Australia is from mid-December to the end of January. In particular, the south and eastern coasts of the country and the most popular travel areas in general are overcrowded during this time and it is difficult to find overnight accommodation spontaneously.

The fact that Australia is "only" one country also has its advantages: one language, no border crossings, one way of life and one currency. Nevertheless, the country offers a varied flora and fauna, as well as a variety of climatic zones.

Highlights in Australia are:

- The East Coast Beaches and the Barrier Reef
- The red centre with its infinite spaces
- Tasmania, the green island

Introduction

- The subtropical north with its national parks
- The cities of Sydney and Melbourne

Many travellers, as well as ever more Australians, choose the route “once around, with some detours to the red centre”.

At least six months and 30,000 km should be planned for this. If a whole year is available, all the better.

If you also want to include remote tracks through the outback in your trip, a few basic requirements must be observed:

- A well-equipped and reliable off-road vehicle must be available
- The required permits must be obtained in advance for certain routes
- For emergencies it makes sense to have a [means of communication](#) with you that is independent of the GSM network
- You should have travel experience in remote desert regions and know how to drive a 4x4



Figure 10 Ann Beadell Hyw.,
Western Australia (underway.ch)

The electronic visa is only valid for three months. For longer stays, a [visa](#) must be applied for, which is then valid for six to twelve months. A CdP is required for the vehicle brought with you. The travel costs are a little cheaper than in Europe, USD 2000-3000 per month should be sufficient (own vehicle, camping, two people) if you don't plan expensive trips and don't enjoy the pub culture too much.

After the trip in Australia, it can be worth shipping a good 4x4 touring vehicle home as relocation goods, because, for example, well-preserved and affordable Landcruiser can still be found, that is hardly the case in Europe. Alternatively, you can ship the vehicle to Southeast Asia and drive it to Europe from there.

Introduction

Hippie Trail

This travel route was created from Europe to Nepal or even further to Goa or Southeast Asia in the 1960s and 70s. At that time, of course, there was still largely no touristic infrastructure. Often people were travelling with old buses and VW vans, a real adventure indeed. After

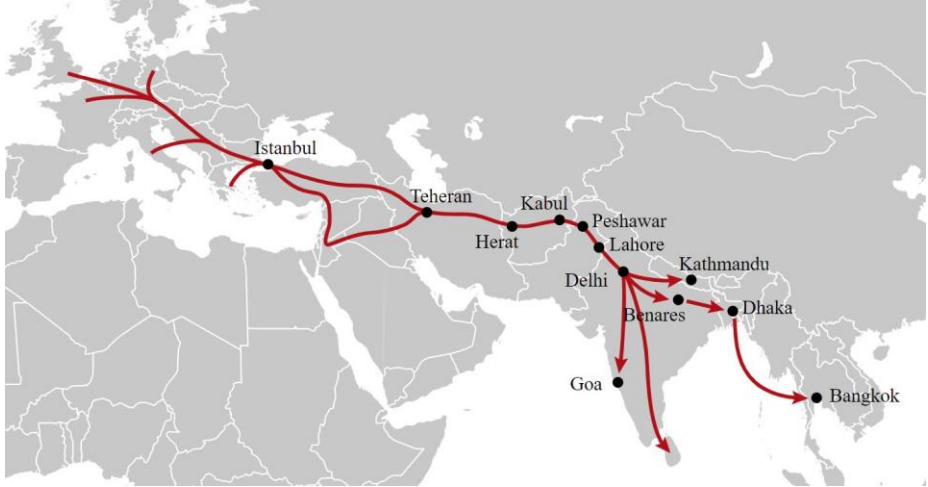

Figure 11 The route of the classic Hippie Trail

Von Karte: NordNordWest, Lizenz: Creative Commons by-sa-3.0 de, CC BY-SA 3.0 de, <https://commons.wikimedia.org/w/index.php?curid=28476198>

the hype at the time, it was quiet about this route, but even today it is one of the most travelled routes in the world, albeit only partially and with modifications.

The route still has a certain appeal and it is also much easier to tackle than it used to be. However, the route will have to be adjusted, especially because of the political situation in Afghanistan. And even today, the road connection from India to Southeast Asia is difficult to access for tourists. Some travellers circumnavigate the region via China. Unfortunately, this variant is complex to organize and, because of the mandatory guide, also very expensive. Shipping from India to Southeast Asia or Australia is therefore a popular option.

Asia Overland

For a planned trip around the world, the route from Central Europe through Russia to the easternmost port of Vladivostok is an interesting option. However Russia is big, and the lonely expanse of Siberia

Introduction

doesn't offer that much. Detours, variants and deviations can be planned, in order to provide more variety. On a more southern route, some of the Stan countries can be integrated and Mongolia is almost on the way.

If this route is chosen, knowledge of Russian language is definitely a great advantage.

Europe

There is no classic route, but Europe is also ideal for a longer journey.



Figure 12 Island (underway.ch)

The region has various advantages, especially if you come from a European country yourself. Then there are hardly any restrictions on the length of stay and the currency in many countries is the Euro. Normal car insurance is usually valid across the whole continent and if something doesn't

work out as it should, nowhere is very far from home to return, and breakdown insurances will even bring the defective vehicle back home in case of a major break-down.

Travellers from outside of Europe will need a Schengen Visa. This allows travelling throughout Europe for 90 days within 180 days. Since this is hardly enough to experience the continent, there is no other way but leave the Schengen zone for 3 months and come back for a second turn. "Escape countries" can be The UK, Morocco, Turkey or some Balkan Countries. The 90 day period can be split over several legs, this allows to leave, and therefore interrupt the counting, the Schengen area. As you come back the counter starts again until the 90 days are reached.

Buying and registering a vehicle as a foreigner is not as simple in Europe. Germany and UK are probably the best options, both have a large market of camping vehicles. When insuring the vehicle look out which

Introduction

countries are covered, because not all companies offer the same “green card” list.

As a camping vehicle, a van or a small, robust motorhome is more suitable than a large vehicle for a trip through Europe, because parking spaces in cities and space on camping pitches are often not suitable for large vehicles (>6m). Many secondary roads are often winding and narrow, in particular in old city centres.

Fuel consumption has a significant influence on the travel budget in Europe, as fuel is generally quite expensive. In addition, road use costs and restrictions may also apply to trucks over 3.5 t.

In terms of logistics and the procurement of the necessary equipment and services, Europe is generally easy to travel within. Supermarkets and shops of the same brand can be found in many countries.

The greatest “challenge” could be the linguistic diversity of Europe, depending on your foreign language skills. Outside of tourist hotspots, also in Europe many people don't speak a foreign language. In Scandinavia, the English-speaking countries, and quite often in Central Europe, you can usually get along well with English. Otherwise, the only thing that helps is “Mr. Google,” or the knowledge of several additional foreign languages.

The cost of living varies greatly depending on the country. However,



Figure 13 Granada, Spain (*underway.ch*)

there are no really cheap countries, maybe best in the Balkans and in some of the Baltic countries. Scandinavia, together with Switzerland, are some of the world's most expensive countries to travel to. However, with an average budget of \$ 3,000 for the monthly running costs, there should be enough reserves to survive. The actual

Introduction

cost depend of course on the type of travel and the expectations.

Europe also has another big advantage: the innumerable sights are usually not far apart. As a result, the distances are shorter compared to other continents. Europe, except from the far north and some countries in the Balkans, cannot offer much wilderness. This is due to the mostly dense population.

On the other hand, it is the continent with the greatest cultural diversity and offers countless historical cities and buildings. The continent, which is rather small, is also top in terms of culinary art.

When Should You Start?

How many months or years in advance you should start planning your trip varies greatly from person to person. Probably the most important factors are the existing travel experience and whether the travel vehicle has already been purchased and tested. If both are available, you can start your trip after just a few months of preparation, provided you have sufficient travel funds.

If neither experience nor vehicle is available, it will probably take a little longer. Additional time will be necessary, if you require detailed advance planning because, researching and gathering information will be quite time consuming.



Figure 14 Just one year before the start of the Panamericana trip (underway.ch)

You are well advised to begin a year or two in advance, because obtaining or setting up a suitable travel vehicle can be very time-consuming. If this is settled and a test trip, lasting several weeks, has

Introduction

been successfully completed, then there is almost nothing standing in the way of the trip

How Long Can or Should the Trip Take?

The most important questions in this context are:

How much time do you have?

or

For how long will your budget last along the route you plan?

Then there are considerations regarding what there is to see and experience along the route, as well as whether the possible schedule correlates with the climatic conditions in the target region. Under certain circumstances, you are sometimes forced to travel through a region faster than you would actually like, just to prevent you from getting into the rainy or the main travel season, for example. Both can also be avoided by interrupting the trip and taking a longer home leave. However, this solution is more suitable for retired travellers and requires an available home base as accommodation in the home country.

Happy is someone who can travel as long as he wants and has a secure income even during the trip. Travellers who are still working usually are in a different situation. If you quit your job and break the bridges to your home country, you have almost unlimited time available, but the costs that arise usually have to be covered by the funds you have saved. More on this in the [“Finance plan”](#) chapter.

The very adventurous Overlanders can simply drive off and travel until they run out of money, and then break off the trip wherever they are. Possible, but that requires a fairly flexible travel style and perhaps a good tolerance for frustration at the, perhaps unwanted, end of the adventure.

If you want to go on a big and really long trip, you should know yourself well, because it is quite common that after a while a certain travel fatigue sets in. When, depends a lot on how intensively one travels, but also on the personality of the travellers themselves. Experience shows that people who travel slowly get tired later than Overlander, who

Introduction

usually do not spend long periods in the same place. Over-saturation due to the many impressions is all the more likely if you want to see and experience everything everywhere. At some point the ability to absorb and enjoy new things is exhausted!



Figure 15 Among like-minded people; Finca Sommerwind, Ecuador (underway.ch)

It doesn't make sense to make a general recommendation for an optimal travel rhythm. However, the experiences of many travellers show a tendency. After one and a half to two years of uninterrupted travel, "signs of wear and tear" often appear. A rest period of several weeks in a relaxing environment in between can possibly counter this, so that the desire to continue travelling will soon reappear.

Since flight prices to more and more destinations have become cheaper in recent years, there is an increasing number of Overlander who regularly plan "home vacations". However, this applies mostly to retired people, as they, of course, have no time restrictions and also enjoy a secure income.

If you take a break in your journey into consideration, it must be noted that in most countries the temporarily imported vehicle is only allowed to remain in the country for a certain period of time. Often you are not even allowed to leave the country without it. Ignoring these regulations can result in severe penalties and even confiscation of the vehicle. A Carnet de Passage can have advantages, if it is accepted by local customs authorities.

Introduction

ATTENTION

The planned duration of the trip can also have a decisive influence on very different organizational factors. Some things get a little more complicated if the journey is to take well over a year. Be it vehicle registration, retirement plans, health insurance and much more are affected. In the following chapters, these points are mentioned comprehensively and the effects or the necessary planning consequences can be taken into account.

Especially if you are thinking of travelling “open end”, comprehensive planning is difficult, and at some point it no longer makes sense anyway. You still have to be clear which factors are influenced by this, otherwise the future, especially if the dreams do not ultimately develop as intended, can turn out to be quite unpleasant. However if you are aware of what could happen in the worst case and are flexible enough to live with it, none of this is a reason not to go on a trip.

Which Travel Style Suits Me?

Unless you have extensive travel experience, it is difficult to imagine which style suits you. What was perceived as perfect on a three-week vacation road trip doesn't have to be the best on a long-term trip. But this topic is also shaped by the financial possibilities and also the “willingness to suffer”. A cyclist can definitely enjoy the splendid adventure of a multi-year trip around the world to the full, despite spartanic equipment, physical challenges and, under certain circumstances, very uncomfortable climatic experiences. Another person, for example, cannot imagine living in a van for months, even years, enduring wind and weather. Between a backpacker and the traveller in an million dollar expedition truck, there are pretty much all kinds of people travelling the world. It would just a shame if it is only noticed underway that the chosen travel style was wrong. In many cases, getting a second chance for a long journey is not given.

Most of the “Club of Normal Overlander” will choose to travel in a motor vehicle.

Introduction

Travelling with Children

Families with children are also increasingly playing with the idea of indulging in a long-term trip. In order to go on a long journey with children, there are a few things to clarify and consider in advance. If parents are planning the trip with children who are not yet of school age, the organizational hurdles are not very great. Mainly the health and social effects on the young team should be considered. The burden on health caused by the climate, environment and diet, can be, if necessary, alleviated by choosing a travel area that is known to be rather easy in this regard. North America, Europe and Australia / NZ would be ideal in this aspect.

However, it should also be borne in mind that small children are not as interested in long drives through beautiful landscapes and visits to museums and churches as their travel-loving parents are. They will also lack sustainable social contact with their peers. They will probably get to know a lot of people, including children, but there is usually not enough time to develop a close, sustainable relationship with them.



Figure 16 Travelling with children (underway.ch)

In the case of school-age children, the arguments mentioned above are less important. But there is the burden of schooling underway, and that also applies to the parents. One should not underestimate the technical and time-consuming effort of “home schooling” on a trip. This is especially true

when more than one child has to be educated. Much has to be done via the Internet these days, especially school materials and exams might have to be sent back and forth online. Learning apps can support learning. But this is exactly where there are often limits on a journey, because Internet speed and availability like at home can usually not be expected. This can quickly turn into hours-long downloads and video conferences become a challenge. Of course, children and especially

Introduction

young people can benefit from all the impressions and experiences of a trip through foreign countries, much more than their peers in a regulated learning environment. But there is also a lack of exchange with schoolmates.

To add to the time burden, just make this comparison: If a normal school week consists of 20 - 30 lessons, you can certainly integrate some of these (e.g. sports, music, handcraft) into the daily travel routine in an improvised and informal manner. However, there are still 3-5 school hours per day plus any homework left. If there are three children to be schooled at different levels of learning, it is easy to imagine that the effort will be considerable. Whether the travel experience is still positive under these circumstances must be judged by the parents themselves.

Travelling parents with relevant experiences made it clear that they had underestimated the schooling effort. Often the regular school holidays had to be “sacrificed” in order to catch up on learning delays. In addition, longer breaks had to be taken in places with a good internet infrastructure in order to be able to learn efficiently, because today self-directed learning is often based on internet-based content.

As a rule, children are only exempted from compulsory schooling if the family gives up their place of residence in their home country. If there are travel plans with kids, it is therefore of great importance to find out from the authorities in advance which duties and school schedules are to be followed and how this should technically be carried out. In this context, you also have to think about the re-entry in the public school and the conditions that may be necessary to achieve this without missing a year.

In addition, you should definitely exchange ideas with parents who have already experienced adventures in this form.

Parents should also reflect on whether a trip of the size and shape discussed here would really be beneficial for the child's welfare or, in the worst case, a education deficit is to be expected, which may impair the

Introduction

connection to regular compulsory schooling after the trip. It is also anything but certain that children will enjoy the trip to the same extent as their parents hope for themselves.

Travelling with Pets

If you already own a dog, you certainly don't want to leave it behind when you go on the big trip. Other travellers will meet a stray dog somewhere along the way who will soften their hearts and become a travel companion.

Travelling with pets is basically possible, but you have to be aware in advance that in addition to having a four-legged companion at your side is fun, there are also disadvantages and limitations associated with it.

Border Crossings

Travelling with a dog within Europe is quite easy, as you have to reckon with no restrictions at borders, provided you have a dog passport, mandatory vaccinations and it's chipped. It can look different in non-European destinations. Often the preparations mentioned are not sufficient, but an up-to-date veterinary certificate and sometimes additional vaccinations are also required. In a few countries, a quarantine or even a complete import ban must be expected.

Complying with all of these regulations can be time consuming and expensive. For example, when crossing the border between Chile and Argentina, a vet's certificate is required that is no older than 30 days. If you consider that you will cross this border several times as part of a common travel route, you have to see a veterinarian again every few weeks.

For other countries you have to register the animal online beforehand, or you will suffer an extra processing fee.

For certain dog breeds, stricter import regulations apply in some countries, this primarily affects so-called "fighting dog breeds".

Introduction

Most difficult, if not impossible, it will be in countries that require quarantine. When entering Australia, for example, countless time-consuming and expensive formalities have to be completed in advance, and entry can only take place via Melbourne, as the animal can only be brought into the 10-day quarantine there. In addition, you need a previously obtained permit, a veterinary certificate, special vaccinations, etc.

The [iOverlander app](#) is a very helpful tool to find out more about the formalities and at the same time to find addresses of the authorities and veterinarians involved.

In general, a pet owner should clarify exactly which regulations and restrictions in the countries to be visited must be observed before travelling.

Vaccinations

As a rule, the animal will already have the vaccinations that are generally used in Europe. Depending on the validity and regulations of the countries to be covered, additional vaccinations will have to be added or existing ones will have to be refreshed, maybe even during the journey.

Pet Food

While pet food can be bought without any problems in most countries, the options in third world countries are much more limited. This can be a major challenge, especially if the animal only accepts the food it is used to at home. In these cases, adequate storage space must be available. In many countries where high quality pet food is not common, the costs can also be quite high.

Animal Health

If you travel in the tropics, the health burden for humans, but also for animals, is quite high. In addition to the climatic challenge, there is also the risk of tropical animal diseases and parasites.

Introduction

National Parks

Most national parks around the world do not allow pets in the wild. Even in campsites within the parks, pets are often not tolerated. That can be a very severe restriction for travellers. At best, you can camp outside the park and leave the dog with someone to look after, while you are visiting.

Public transport

Similar restrictions have to be accepted when using public transport. Be it in the bus, train or taxi, in many countries, including third world countries, it is not possible to take the dog with you.

In the case of air transport, on the other hand, it is less problematic to transport the pet. Small animals may even be taken into the cabin, while large animals can travel in the air-conditioned cargo hold. Either way, the animal has to travel in a certified transport box and the cost of the trip can be quite expensive.

Access to Public Spaces and Overnight Stay

Even access to public spaces, as well as restaurants and shops, is often severely restricted. The same applies to hotels and even to campsites, albeit much less there.

Adopting Street Dogs

In third world countries you will again and again come across dogs



that obviously do not belong to anyone. Often these are unfortunate animals and it is not surprising when someone becomes friends and soon also thinks about adopting the animal as a travel companion.

Figure 17 A pet on board can be enriching (*underway.ch*)

Introduction

But be careful, the dogs are not always ownerless and local laws regarding ownership rights must also be observed.

Before you decide to take responsibility for the dog, you should reflect again on the factors outlined above.

This may all seem very negative, but it will (hopefully) not prevent real dog lovers from taking the dog with them on the journey. That is not the reason for this information either, but rather it should help to make the project possible and to show what one is confronted with in advance and on the trip.

The following website offers extensive information on the subject: [>LINK< \(GE\)](#)

Financing the Trip

There are basically two possible options to finance a world trip:

Either there is enough capital available, respectively enough savings can be put aside, or you can count on a secure and constant income on the journey.

Income on the Trip

Obtaining enough funds on the go through odd jobs is rather the exception, because short-term jobs that are accessible to travellers are often illegal and almost always poorly paid. Working as a harvest worker on a farm for a few weeks is certainly a good experience, but you won't get very far with your earnings afterwards. In addition, there are only a few regions where this is possible at all. Performing a board and lodging job, including for charity, can be very satisfying and enriching. It also helps to clear your head from the many experiences and to overcome a pent-up reluctance to travel. But be careful, not all charity jobs are free. Often the organizations not only expect free labour, but also a cost sharing of over \$ 1000 per month is not uncommon.

Introduction

Digital Nomad

Another possibility is to work as a “digital nomad”. If, however, appropriate relationships have not been established in advance and such jobs have not been done before, the chances of being able to make a living from it on the journey are vanishingly small.

Even if you think about making money with photos or press articles, the prospects are hardly lucrative enough to "extend" the trip without previous, successful relationships.

In any case, the availability of a stable and fast internet will be a challenge for this kind of business. So it may be necessary to be tied to a place for a long time just to be able to work at all. However, it is not certain whether this place will also be beautiful and worth living in. When making an assessment of such a lifestyle, one should not rely on the positive experiences of a few "influencers" who have become rich.

Renting or Selling Your Own Property?

Renting out your own property can be a very good income opportunity. This is especially an option for “mid-aged” travellers who already own a house and do not want to use it during the trip, but want to move in again after their return. Of course, it is ideal if the property can be rented out furnished, so that the furniture does not even have to be stored. But letting can always be fraught with risks, especially if the tenant is not known beforehand. If there are no helpful friends or relatives at hand to take care of the tenants and general administration, a fee-based property management service will reduce the income.

If you are ready to finally break the bridges behind you, another option is to sell the property and invest the money profitably. It should be noted, however, that selling a house can sometimes be a lengthy affair. The possible risks must also be taken into account when investing money. Who manages the assets and the investments? Is the facility safe enough? Can the profit generate a substantial share of the income or does it have to be drawn from wealth? In any case, it is important to work with a reputable asset manager who can also support you in drawing up a budget and a financial plan.

Introduction

Retired Overlander

Already retired travellers are often in a more comfortable situation, as they can count on a regular pension. Depending on the travel region, this is often sufficient to at least cover the running costs, but they too must be able to fall back on savings for larger and unexpected expenses.

In order to get an idea of the expected costs, please refer to the chapter [“Financial Plan”](#) below.

Planning



Planning

Every Beginning is Difficult

As indicated above, travel planning begins months or years before the adventure starts. The most important step is and remains the decision to do “it”. Everyone will develop concerns and doubts sooner or later. But you shouldn't let yourself be influenced too much by negative scenarios. Rarely, very rarely, has a traveller returned home harmed. On the other hand, anyone who has been on a trip can tell of many, very many wonderful experiences and memories.

Of course, something can go wrong, but hey, is it different at home? It is certainly reassuring not to have to move financially on the edge from the start. If major damage to the vehicle would mean the end of the journey, then you definitely started with too little reserve. But that won't kill you either, will it? You wouldn't be the first Overlander who inevitably switched to backpacking trips after a major vehicle damage.

So, the dream should now be turned into a real adventure!

Financial Plan

Unfortunately, nothing works without money, even though there are adventurers that have started with nothing in their pockets and have been on the road for months and more. But of course, that is only possible if you count on the people you meet on the way and target to be “fed”. It is fair to say that this type of travel is not suitable for the masses and that it is even questionable to travel at the expense of others.

Planning

Unfortunately, it is not possible to make a blanket statement about the costs of a trip, because not only are the costs of living different in all regions, but the expectations of individual travellers also cover a wide range. In India you can travel for a few dollars a day, provided you travel by public transport in the "cattle class", eat like the locals from street stalls and have little fear of using dodgy overnight accommodation. In contrast, you will have to budget quite a bit for a trip to the USA, especially if you would like to spend the night in a fine hotel or dine in a trendy restaurant from time to time and don't want to miss anything that local tourism and culture have to offer in terms of entertainment and adventure.

This book can only offer assumptions and estimates that are in a balance between the two extremes above. It is best to guess your own costs in comparison if you already have your own travel experience, even if only from short trips, and you are clear about your own needs and preferences.

Budget

Before you can even start, some of the biggest expenses are usually due, especially if the touring vehicle has to be procured or built. However, all of the travel equipment, if not already available, also has an impact on the expenses. In addition, there are flights and the shipment to the starting point of the trip.

The actual travel budget, i.e. the expenses to be expected when you are on the road, is basically composed of the following types of expenses:

- Fixed costs
- Time related costs
- Distance-related costs
- Special costs

Fixed costs include all unavoidable and recurring expenses such as travel and health insurance, subscriptions for telephone, web hosting, taxes at home, any costs for the storage of furniture, etc. So everything

Planning

that has to be paid for, regardless of where you are or what you are doing.

The expenses for food and drink, overnight accommodation, admissions to sights, expenses for the procurement and replacement of equipment are added to the time-related costs. So, the longer the trip, the bigger this item.

Distance-related costs relate primarily to vehicle costs, i.e. fuel, wear and tear and maintenance. The more kilometres you cover, the more expenditure these costs will take.

The special costs are made up of expenses that do not fall into one of the aforementioned categories. This includes, above all, flights and shipments en-route, but also unpredictable, large repairs and health costs. Any home leave and extraordinary, expensive side steps would also fall into this cost category.

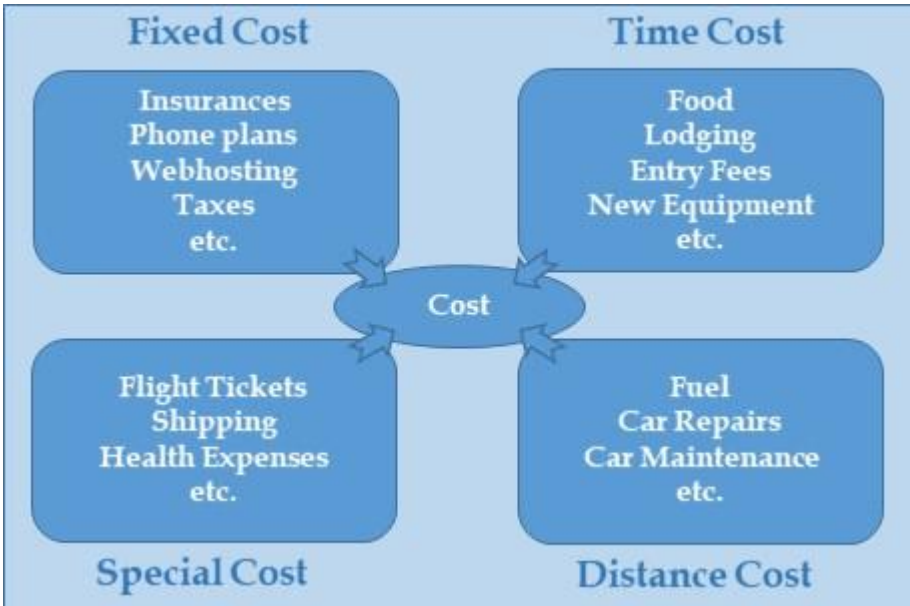

Figure 18 Cost categories

Planning

The following example should explain this:

The planned route of choice covers 50,000 km. The vehicle costs for this route can be estimated as follows, for example: 13 l / 100 km consumption and a fuel price of approx. \$ 1 / l = \$ 6500, plus service costs / insurance of approx. \$ 3500. That gives a total of about \$ 10,000 or \$ 0.20 / km. While it is relatively easy to estimate fuel costs, it is a little more difficult for maintenance costs, since the prices of the workshops on the trip are unknown. But these are often cheaper than in your home country and sometimes only cost a fraction. The service interval, on the other hand, is known again.

An estimation of the fuel prices to calculate the budget can be found here: [>LINK<](#)

The plan is to set aside a year for this trip. That means roughly 400 days of eating and sleeping with a daily average of \$ 40, costs of around \$ 16,000. For this budget item, the daily average expenses are highly variable and differ from country to country.

Total travel expenses in this case: \$ 26,000.

If the trip is now to last twice the time for the same route, the kilometre costs remain the same (\$ 10,000) but the time-related costs double (\$ 32,000).

The total cost is now \$ 42,000. In other words, the second year of travel is only \$ 16,000.

The example is calculated for two people in one vehicle. If a person travels alone, the cost of getting around remains exactly the same. The time costs can be reduced, but not simply halved. This results in the knowledge that if a trip is made in pairs, not only two people can contribute to the savings before the trip, but the total costs per person are significantly lower. The obvious logic would now be, that if the number of people traveling together were to be increased further, the per capita costs would also decrease. That is absolutely true, but while travelling as a couple is usually very enriching, a group trip, in addi-

Planning

tion to the financial advantages, holds great potential for crisis, especially on a social level.

Now, of course, there are also the "extraordinary" and the "fixed" costs. On this basis of calculation you can make your own considerations. Above all, it should be possible to estimate the cost of the vehicle per kilometre and the daily expenses.

Basically, there are travellers who have a lot of time, but have a tight budget, and then there are those who have enough money, but only limited time. There are also the privileged retirees who have a lot of time, and hopefully enough income, to be able to afford a trip. So everyone has different approaches to financially planning a trip.

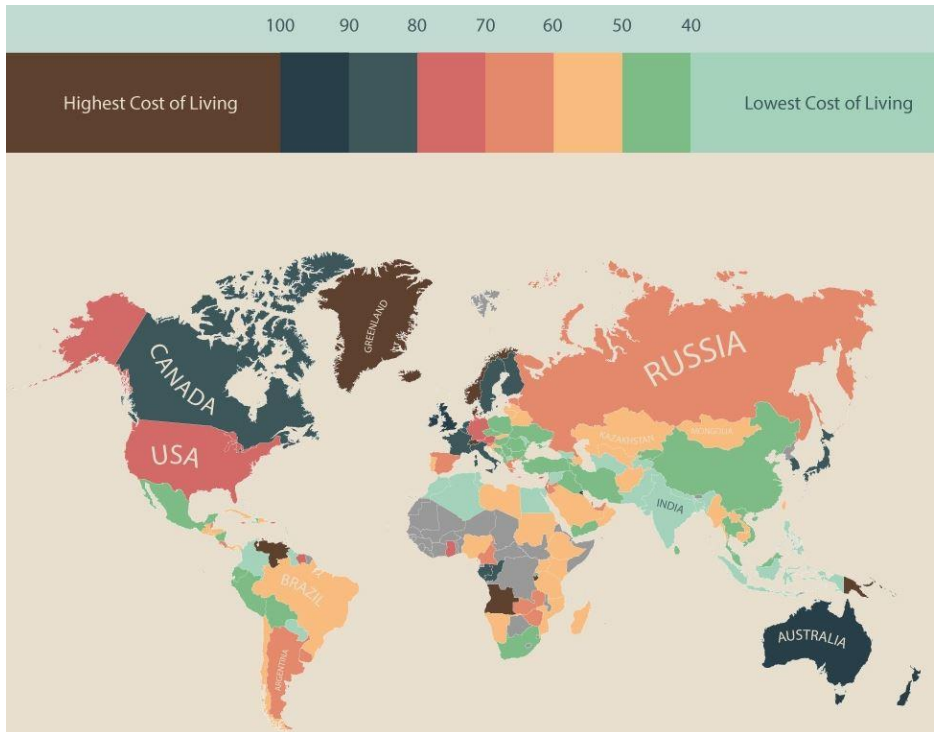

Figure 19 Global overview of cost of living
<https://cdn.lifehack.org/wp-content/uploads/2015/01/cost-of-living-original.jpg>

Planning

It should also be noted that the current travel costs are heavily dependent on the average cost of living in the region visited.

The map above shows which regions are more expensive and which are on the cheaper side. This can already help as a rough planning basis; also, many travellers have presented their own costs, some of them in great detail, on their websites. Such information can also help with your own planning. An example: [> LINK <](#) (GE)

The map gives a rough overview of the cost of living in the individual countries. However, due to variations in exchange rates and inflation, there are repeated, sometimes striking, shifts. Equally important, many of the cost of living items do not affect the travel budget (local rents, taxes, etc.). Other costs that are relevant for Overlander are not or only little taken into account in the graphic (tourist excursions, hotel / camping accommodation costs). But despite everything, a trend can be deduced that is not too far off.

It is not entirely wrong if the following breakdown of running travel costs is used:

- 1/3 for food and overnight
- 1/3 for vehicle costs
- 1/3 for all other running costs

Probably the simplest, but most inexact, way of estimating the monthly travel costs is to estimate an expected length of stay for the respective country to be visited and then to calculate the expected costs with the help of the key shown below. In order to take into account your own needs and demands, you can choose a rather high or rather low basis for the calculation or use an average value.

Region	Cost / month
Cheap Country Asia and Africa with exceptions	500-1000 \$

Planning

Middle priced Country South- / Central America, Southern Africa, Europe, Australia	1500-2000 \$
Expensive Country North America, Switzerland, Scandinavia, Japan	2500-3500 \$

Cost basis: medium-sized vehicle (van, 4x4) 4000 km / month, mostly self-cooking, half of the camping is free, few restaurant visits and expensive, paid activities, 2 people.

The above approximation is based on the effective cost of a Panamericana trip 2016-2018. The graphical summary shows that these reflect the picture quite well. However, as mentioned, the breakdown can also vary depending on the type of trip and region.

Whenever possible, either a generous cash reserve should be created, or rather high running costs should be used, when planning the budget. For example, if you put \$ 5000 / month into your budget, you should create enough reserve at the same time, even for larger breakdowns, or otherwise it leaves space for some exclusive, spontaneous

excursions, pampering programs, home holidays, surprises, etc. It is also advantageous, if after the end of the trip there is still something left for a new start at home, especially if you have to look for a job and a place to stay again. In cheaper travel regions, a much lower amount would also be sufficient.

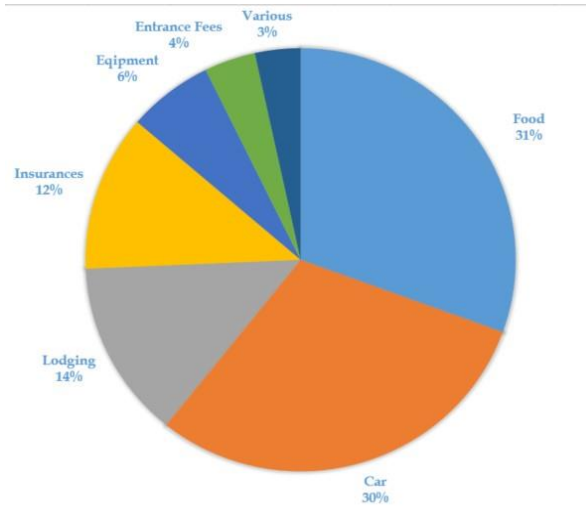

Figure 20 Cost splitting of a Panamericana trip (underway.ch)

Route Planning

Once a rough travel plan has been developed, you can start planning a route. There are various aids and methods for this. The Internet offers inspiration through relevant travel reports from other travellers, or active participation in travel forums and social media help to establish contacts and exchange experiences. In such groups, however, it does not go down well when questions are asked such as: "I want to go on a trip around the world, what are the Must See's and what does it cost?" It is better to research beforehand that the questions are more specific and can therefore be answered better. In general, the Internet is an abundant source of information par excellence, even though it is not always easy to ask "the right question".

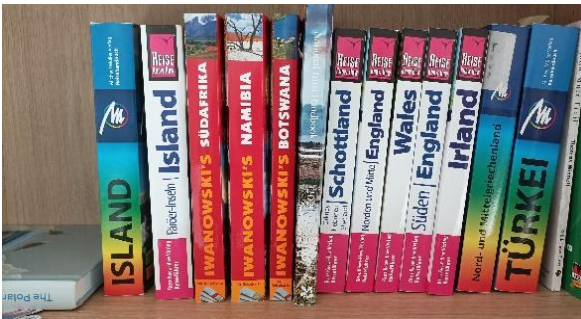

Figure 21 Travel guide book, a good source of information (underway.ch)

If the rough route has already been determined, further sources are current travel guide books for the planned travel region. Additional details can then be determined based on these. But even the latest travel guides will

never keep up with the actuality of information on the Internet. Unfortunately, they are also still crammed full of hotel and restaurant recommendations, for which the Internet is definitely a more practical source. In general, only a few travel guides are optimized for independently travelling Overlander, because they mostly focus on people who travel by plane on vacation. Nonetheless, these books can provide information on popular sights and, above all, comprehensive background information on the country and its people. Depending on the scope of the journey, however, this can result in a large number of thick tomes that have to find space somewhere. There are also many travel guides now available as e-books, although it should be noted that these are mostly simple .pdf versions of the printed books. Unfor-

Planning

unately, this format is not very handy for browsing, but it saves a lot of space and weight.

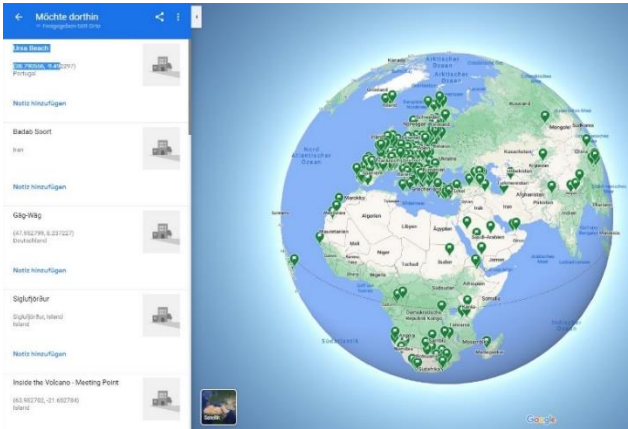

Figure 22 Planning with Google Maps (underway.ch)

On television or a friend tells you about a secret spot, a pin is placed on Google Maps and a meaningful note is written and the information is saved. The entries can also be sorted in categories or in regional lists to keep track of things. Google Maps also allows sharing these lists with other people. As a couple, you can independently add contributions to this list. This information can of course also be continuously updated on the trip. When planning a route with the help of this map, it is easy to determine a route that leads past many of these places. It will probably never be possible to visit all of these places, but there are nevertheless focal points for determining the rough travel route. The only disadvantage of this method is that an internet connection must be available for use underway. Google Maps can only be used offline to a limited extent if the maps were previously downloaded by region. However, the personal pins are always saved locally.

Another possibility is to collect information whenever it appears and to bring it together centrally. Google Maps is well suited for this. If an article appears somewhere about an interesting place, an exciting documentary is broadcast on

Best Travel Season Respectively Start Time

It is very important, not only at the beginning of the trip, to pay attention to the climatic and seasonal conditions. Almost every region has ideal and less travel-friendly seasons. But if you start at the wrong time of year, this can lead to frustration right at the beginning of the trip. The days are cold, it rains a lot, the tourist infrastructure is largely

Planning

closed, and that's not how the adventure was imagined. But even the ideal season has its pitfalls. Campsites are overcrowded, the capacities of the national parks and other sights are exhausted and the prices are higher than normal.

So it is important to find out how the best compromise between the two extremes can be found. Luckily there are of course still many areas where there are no overcrowded sights to watch out for and, where hardly anyone else will be on the move, but the reality is that more and more destinations are being "discovered" by mass tourism.



Figure 23 Seasonal planning for South America
(Source: <https://weltreise-info.de/route/reisezeiten.html>)

As an individual traveller, however, you have good opportunities to evade. However, sometimes you just have to leave something out. In any case, it means that you have to invest a lot of time in research in order to achieve the optimum.

An interesting source with a lot of weather statistics and travel time recommendations is the website "[Best Travel Time](#)" (GE). Using this information, a route can be optimized in terms of climate and travel time. On the website "[weltreise-info.de](#)" (GE) you can compile your own table that can be used to optimally display a regional travel schedule (see picture)

Planning

Set the Duration of the Trip

Once the route has been determined, a time window is worked out to estimate the time requirement to travel the route while fulfilling the own expectations. If there is no time limit and there are no other obligations to be met, the focus of the time planning can be reduced to the seasonal aspects. It makes little sense to try to force a trip that may take several years into a time frame while you are still at home, because: firstly, it turns out differently and secondly, than you think.

If, on the other hand, a defined time window is given, the planning is of course reversed. Then it has to be considered how many desired destinations fit into in the given time window. Less is usually more, so it's better to do a little less and experience everything more intensely.

Define a Schedule

Actually, the same as above applies to a schedule. However, it can also be helpful for travellers without a time limit to divide the months ahead into time segments, be it just to check whether you will be traveling in the correct seasonal period, or to determine when and where to obtain the visas for oncoming countries.

If you follow other travellers planned routes and timetables on their websites, it can often be observed that planning and reality sometimes diverge remarkably, in both directions. That's not really a problem, especially not if you can enjoy your own trip without having to obey a planning corset. There is not a single valid opinion on this topic either; it is dealt with on a very individual basis.

If the travel route has already been determined, the time required can also be roughly planned by taking a monthly or daily distance you want to cover as a basis. Depending on the style or speed of travel and the region visited, this criterion also varies considerably. In regions such as Siberia, Patagonia, Central Australia or Northern Canada, due to the large distances and the few sights, you will experience longer daily stages and fewer days of rest. This is different in Europe, where

Planning

small and densely populated countries predominate, and therefore a lot can be experienced over short distances. However, individual travel behaviour and, last but not least, the vehicle used have even more influence on the average stages. Truck owners tend to travel slowly because of the better living comfort, but also because of the higher vehicle costs, while roof tent travellers and people who live outside will hardly stay long in areas with a cold, damp climate.

The following table can provide a guideline:

Worth seeing>	little	average	Much
Fast travellers	250 km/day	150 km/day	100 km/day
Average	150 km/day	100 km/day	50 km/day
Slow	100 km/day	50 km/day	25 km/day

These average values have to be viewed over the longer term because they also include days without driving. The author's journey of over two years resulted in a distance of 100,000 km, which is an average of around 125 km / day. However, this also includes months with up to 6000 km, which corresponds to a daily average of 200 km., compared with months with a lot of stationary days and short daily distances. Many Overlander cover on average 100-150 km / day on long journeys. If you don't have any personal experience, you can use this as a basis. Personal experience from vacation trips will mostly be higher due to the limited time.

Linguistic Proficiency

Communication with the population in the countries you visit is an exciting and very important part of travelling. Foreign language skills are not only of great importance for obtaining information or dealing with authorities; if you are interested in the way of life and culture in foreign countries, you want to be able to talk to people!

Not everybody is a talented learner of foreign languages per se, or can fall back on existing foreign language skills. There is also the fact that,

Planning

often encountered in touristically developed areas.

The structure of the Asian continent is probably the most complicated. Not only does the variety of languages make it more difficult, but these are also very different from the Indo-Germanic languages we might be familiar with. It is correspondingly difficult to learn these languages too.

English is most widespread among travellers and in regions that have developed into tourism. Common software tools and information sources are often only offered in English. You should therefore have at least basic knowledge of this language. It is interesting to note that although only just about 400 million people speak English as their mother tongue, but a further 800 million people have learned English as a second language (see above). Half a billion people speak Spanish, the majority in Latin America, but it is not widely used as a second language worldwide.

It is definitely worthwhile to have a basic knowledge of the most common language in the travel region. With a little talent and will, these can also be quickly developed on site.

In Latin America in particular, it is popular to plan a language stay of several weeks at the beginning of the trip. This is usually quite inexpensive and also offers an excellent opportunity to familiarize yourself with the mentality and culture of the host country, and to slow down from the hustle and bustle from before you start your journey. If you bring basic knowledge from home with you to the course, you will benefit all the more from rapid and major progress.

An interesting article on the language topic can be found on Wikipedia here: [>LINK<](#)

Vehicle procurement



Vehicle procurement

If you don't own a vehicle yet, it is now time to take care of it. The selection and procurement is a demanding and time-consuming task and should be tackled early enough. A year can quickly be wasted, because defining and finding the right vehicle is not easy. The market for suitable vehicles is quite large in Europe, but when the requirements are high and the budget is modest, patience or a willingness to compromise is required.



Figure 25 A truck or something smaller? (underway.ch)

If you plan to prepare the vehicle yourself, you have to allow for even more time. Not only does the search for a base vehicle take time, but you should definitely plan an extended

test trip before you go around the world.

The subject takes up an extensive volume of the book. At first glance this may seem exaggerated, but at least your future "home" will be decided upon. Small technical details can have a significant impact on comfort and cost, but also on safety. In any case, it will be difficult to make larger adjustments or changes while on the trip.

Vehicle procurement

Even people who already own a travel vehicle can reflect here on whether the points described here match the existing vehicle, or whether adjustments appear necessary.

However, in principle, this topic does not necessarily have to be given too much importance, because as a matter of fact you can travel with any vehicle. It is not least a question of taste, budget and a willingness to make compromises.

Basic Considerations

The first question that soon arises is what the ideal camping vehicle would be. In order to get an answer to this, a few basic decisions have to be made. One possibility is to define all the requirements and expectations for the vehicle, however, the vehicle might become a “Jack of all trade & master of none” and possibly leading to an overstretched budget as well.



Figure 26 One can also travel with a basic set-up([underway.ch](http://www.underway.ch))

Well, so much in advance: There is no such thing as the perfect vehicle. At best, all personal ideas and wishes can be fulfilled. After the procurement, it still remains to be tried out whether expectation and fulfillment match.

The following chapters are not intended as a guide to the perfect solution, but rather should shed light on the advantages and disadvantages based on experience, as well as facts about the most important criteria. Based on this, it should be possible to create a more precise requirement profile tailored to your own needs in order to then look for the dream vehicle or build it yourself.

Vehicle procurement

Residential Section of the Vehicle

This chapter decides whether you will be traveling in a truck or a more compact vehicle. E.g., if the requirements for living on the road are very high, a 3.5 t vehicle will most likely not be suitable.

Sleeping



Figure 27 Sleeping comfortably on a trip is important (underway.ch)

There are travellers for whom only a built-in bed is an option. This in turn means that you have to factor in about 1.5 m additional vehicle length or plan an alcove bed. But if you are flexible on this point, a more compact solution can also be considered.

Comparison of the options:

Fixed bed (lengthways, across or bunk-bed)

Advantages	Disadvantages
No bed installation in the evening, bedding can be left	Required space much larger
One person can sleep, the other work / sit	
Good roomy feeling	

Vehicle procurement

Alcove bed

Advantages	Disadvantages
No bed installation in the evening, bedding can be left	The vehicle usually builds higher
One person can sleep, the other work / sit	Little headroom
Extra storage in daytime	Depending on construction, more difficult to ventilate

Bed in pop-up roof

Advantages	Disadvantages
Set-up with little effort	Often limited bed width
Sometimes one person can work the other sleep	„stealth“ sleeping impossible because of pop-up roof
Well ventilated	With strong wind and cold problematical

Lifting bed

Advantage	Disadvantage
Set-up with little effort	If bed is in use, no workspace available
Uses up little space if stowed away	Mechanism can be a source of error
	Cost

Vehicle procurement

Converted bed from seating group

Advantages	Disadvantages
No extra space required	If bed is in use, no seating possible
	Few options for a good quality mattress
	Size might be limited
	Needs more effort to set-up



Figure 28 A comfortable bed is worth its weight in gold (underway.ch)

A good quality of the mattress is definitely worth its money. If you want to travel long term and in different climate zones, a comfortable and well-ventilated mattress should not be missing. A comfortable sleeping environment is extremely important, especially in a tropical climate. Travellers with sensitive backs should pay special attention to their

choice. But be careful, a mattress like at home is not only heavy, it is also very thick and can therefore hardly be used in small vehicles. But there are several good solutions commercially available. A [Swiss Fanello bed](#) offers very flexible solutions for a tailor-made bed or even just a mattress. The products enjoy a good reputation and are of high quality and durable.

Seating

On cold evenings, and if you are stationary for a few days in bad weather, you will spend many hours in the vehicle. It is therefore advantageous if the seating is comfortable and there is enough space

Vehicle procurement

available. This can be a limiting requirement in smaller vehicles, and if you like to have visitors, four seats are appreciated.



Figure 29 Large benches even in a small vehicle (underway.ch)

Rotatable driver and passenger seats save space, but are usually not optimally placeable at the table. In addition, the driver's cab is usually poorly insulated and therefore much colder than the living area. In this case, it is particularly useful to additionally insulate the driver's cab or at least to provide insulating covers for the windows.

dows.

Actually, you should also consider getting better driver seats to replace the original ones. After all, you often sit in the vehicle for hours when you are out and about. If, for example, Recaro or similar seats are installed for driving, you have made an expensive, but certainly worthwhile investment. They will keep the quality for years and your back will thank you for it. In addition to improved comfort, the seats also offer significantly better lateral support and contribute to better safety, especially in off-road vehicles.



Figure 30 Bucket seats improve comfort (underway.ch)

Cooking

Most vehicles use gas stoves. This has the advantage that, with proper ventilation, you can safely cook inside. When gas is burned (butane, propane), however, a lot of water is released (chemical reaction when gas is burned). This can lead to condensation, especially in cold temperatures. In addition, depending on the gas system, filling / exchanging gas tanks is difficult in many travel regions. Either the necessary

Vehicle procurement

connection adapters are missing or it is even forbidden to fill foreign tanks. Permanently installed gas tanks, on the other hand, can often be filled inexpensively at car gas (LPG) filling stations, but here too there are different connections and rules.

You can also work with a diesel stove with a ceramic hob. But beside the advantage of being able to use on-board fuel, they also have some decisive limitations. The warm-up time is around ten minutes, for example. That means it takes time to make a quick coffee. Another problem arises when you want to travel over 2500 meters above sea level. Most models cause difficulties at high altitudes. In addition, the hobs are quite expensive and, once on the go, can only be repaired or replaced with difficulty, if at all.



Figure 31 Outdoor cooking with gasoline stove (underway.ch)

Cooking with an open-flame gasoline stove has some advantages, but of course also decisive disadvantages. The biggest advantage is that petrol is cheap and easily available everywhere. These stoves also have an excellent heating

capacity and high altitude and cold temperature hardly have any influence on it. On the other hand, they must NOT be used in closed rooms because of the danger of carbon monoxide poisoning. The starting of the devices also needs some getting used to. The necessary pressure in the tank must first be built up using the pump; only then can it be ignited.

Alcohol stoves are easy to use, but have less heating capacity. In addition, alcohol is not easy and / or inexpensive to obtain everywhere.

Vehicle procurement

A combination of two systems offers decisive advantages. For example, a built-in gas stove for the quick coffee and for cooking in bad weather, as well as a Coleman 424 two-burner stove for outside cooking. The redundancy pays off. If the gas bottle is surprisingly empty and cannot be filled immediately, you have another option to cook independently of this.

Cooling

A cold beer around the campfire is a great luxury. To keep it cold there are refrigerators with different functional principles. The size of the refrigerator not only has an impact on the space required, but also the greater the volume of the fridge, the higher the energy requirement. Since gas is not always so easy to obtain everywhere, electrically operated refrigerators have their advantages.

Absorber Fridge

Advantages	Disadvantages
Inexpensive (Peltier element models)	Cooling only about 15..20 °C below ambient temperature
Combi models 230 V / Gas / 12 V available	Needs to be level to work properly
Silent operation	Not very energy efficient

Compressor fridge

Advantages	Disadvantages
Very powerful (even freezing is possible)	Needs sufficient electrical power (approx. 30Ah for a 50L fridge per 24h operation)
	More expensive than absorber

Combination absorbers are usually built into commercially available recreational vehicles (RV) because it is assumed that the vehicle at the

Vehicle procurement

destination is either connected to shore-power or is operated with gas. While driving it operates on 12 V yet not very efficiently.

When traveling to remote and hot countries, however, a compressor refrigerator will probably have to be used. There are fridges with front door or chests. The former can be filled more orderly, chests usually keep the cold better and therefore need less electricity.

There are refrigerator models with an integrated, small freezer compartment. This makes it possible to enjoy a drink with ice, or to store frozen food for a few days, but nothing more. On these models, in a tropical climate a thick layer of ice forms within a few days around the heat sink, which significantly degrades the cooling performance. Therefore, you will have to defrost more often. There are also designs in which the ice compartment can be fitted only if needed.

It should be noted that an electric refrigerator is usually one of the largest consumers of electricity on board. The battery and solar system must be designed accordingly. In the case of gas-powered devices, the consumption in hot climates will require correspondingly large gas supplies.

Storage

You can never have enough, you might think. This may apply to a truck, but with small vehicles (<3.5 t), a lot of storage space often leads to overloading.



Figure 32 Valuable outside storage (underway.ch)

On long journeys, it makes sense to have enough and easily accessible storage space. If you already have experience with long-term travel, it is easier to estimate where and how much storage space is needed. Otherwise, you should lay out and group the expected equipment (clothes, kitchen, tools and spare parts, food, camping chairs and tables, etc.) Then divide into what should be quickly accessible and what can be stowed in the “basement”. Now you should get

Vehicle procurement

a feeling of where, and how much storage space is required. If a workable solution emerges, the problem is off the table. Otherwise, you should slim down your equipment, live with the compromise or consider a different vehicle concept.

Generous outside storage compartments are valuable for storing everything you need outside, such as recovery gear, camping furniture and possibly dirty equipment.

Travelers with compact vehicles often tend to take unnecessary equipment with them on the trip. This then leads to overloaded vehicles and the accessibility to important equipment suffers.



Figure 33 If needed, a robust roof rack is a must (underway.ch)

used outside must be robust, lockable and dust / waterproof. Attention should be paid to accessibility.

Roof racks are another way of creating additional storage space. You should make sure that the supports are sturdy and numerous. Roof loads should not be too heavy in order not to unnecessarily elevate the centre of gravity of the vehicle. For campers with a pop-up roof, the possibilities of a roof rack are severely limited. Aluminium or plastic boxes

To ease the problem of overloading, many inexperienced Overlander are forced to “slim down” the equipment soon after the start of the journey. It is definitely better to optimize everything before departure.

Water Supply

Drinking Water

It is important to determine at an early stage how much water you want or can bunker. If you are reasonably modest, you can get by with 10 litres of water per day for two people, but a daily shower with sup-

Vehicle procurement

plies on board is then hardly possible. In addition, you will also need a few litres for drinking and cooking. To ensure that water consumed directly from the tank is not harmful to health, it should be filtered or at least disinfected. Buying drinking water in bottles is not only expensive and requires a lot of storage space, but you should also take into account the correct disposal of the empties when making the decision.

Water tanks are usually made of plastic, otherwise stainless steel is used. Plastic or stainless steel custom-tanks can easily be welded from plates by a specialist company. Large tanks, from approx. 0.25 m² floor area, should be equipped with baffle-plates, on the one hand to tame the centrifugal forces of the moving water masses and on the other hand to give the tank additional stability. A significantly cheaper solution are tanks in standard sizes, which are offered in many dimensions. In any case, it is important to foresee a generous, ideally easily accessible maintenance opening, and to ensure that a level sensor can be installed if necessary. Furthermore, it must be considered where and how the tank can be filled.



Figure 34 Drinking water directly from a mineral water plant (underway.ch)

A separate drinking water tank inside the vehicle has the advantage of only filtering what you need for drinking/cooking/brushing your teeth and that water generally cannot freeze inside the car while on the move. For winter temperatures, external tanks can be equipped with electrical heating, but at low temperatures this requires electricity and not too little. Good insulation is only useful for bridging cold nights. In a permafrost environment, even during the daytime, this is not enough.

Vehicle procurement

Drinking Water Treatment

There are several ways for the treatment of drinking water. A distinction is made between:

- **Disinfection**
This step eliminates bacteria and viruses. This can be achieved with the help of disinfectants, UV radiation and fine ceramic filters.
- **Taste elimination**
Whether it is chlorinated water or from a surface water source, it often has an unpleasant odour or taste. This can be eliminated with an activated carbon filter. It also absorbs heavy metals, hormones and drug residues. It is only suitable to a very limited extent for removing viruses and bacteria.
- **Solids removal**
This is done by using ceramic or carbon filter cartridges. To relieve these fine-filters, however, it is worth using a pre-filter.

Filter Solutions

To achieve the above purification stages, there are combined approaches. With a filter that combines ceramic and activated carbon, you can do all three stages in one step. Or you can combine a simple activated carbon filter with a silver ion cushion in the drinking water tank.



Figure 35 Small active carbon filtre (underway.ch)

with filtered water, a powerful pump is essential. However, be careful,

Vehicle procurement

the piping system must be able to withstand a pressure of more than 5 bar, which is not the case with all products. Since the permissible amount of water that can be safely filtered depends on the filter size, a large model must be chosen if you decide to filter the entire amount of water. Then it is best to connect a ceramic filter and an activated carbon filter in series. Disinfection with silver ions and a small activated carbon filter makes only sense if you are planning a separate drinking water tank or piping. In any case, when filling, you should install a coarse filter in the hose or at least directly after the tank to prevent the fine filter from clogging prematurely. Whichever system one chooses, it should not be forgotten that appropriate replacement material is carried along, since these are difficult to obtain in less developed regions.

For safety reasons, most manufacturers recommend replacing the filter after 6-12 months at the latest, regardless of the amount of water filtered, or after a flow of 3000-8000 l. If the vehicle is decommissioned for a longer period of time, the filter cartridges should be removed and stored in a dry place.

Before recommissioning, it is advisable to clean the tank and the pipe system with appropriate cleaning chemicals. The filters are only put back in place again AFTER cleaning and thorough rinsing.

Disinfection

A common way to disinfect drinking water is the use of a silver ion cushion in the tank. This is a low maintenance and effective solution and it is not expensive. Silver ion solutions can have some harmless effects on the digestion system of sensitive people and in Europe the method is no longer certified in public drinkingwater networks. In camping applications it is still accepted and widely used.

As an alternative, yet similar in use and cost, there is a product on the market that is free of silver and also prevents biofilm in the tank and piping system. More details and function can be found here: [>LINK<](#)

Both of the above solutions maintain the disinfection for about 12 months and are self-dosing. Only when you plan to store the vehicle

Vehicle procurement

for long time or if you intend to chemically clean the watersystem the devices should be removed.

As a reliable and effective method a UV system can also be used to disinfect water. Strong UV light kills viruses and bacteria. This solution is more used in large tanks and vehicles, because the space and power consumption are significant. However, there are also devices that can



Figure 36 UV Deseinfecting device
(Source: <https://www.tw-des.shop/>)

be installed in the water pipe that disinfect the water on the way to the tap.

In the meantime smaller designs to be installed inline just before the tap could be considered. These type of device uses only about 1.5 A at 12 V when in operation. The only real disadvantage might be the price of several hundred dollar and more. To get an idea about such a product: >[LINK](#)<

There is also the solution of filtering all the water during bunkering. That hardly makes sense, because in many countries the line pressure is simply not sufficient. The problem is particularly relevant if you want to fill large volumes. It can quickly take 1 hour or longer until the tank is full. Other people waiting at the tap will not appreciate that. Of course there are a number of technical solutions to solve this problem (e.g. booster pump), but you should tend towards simple solutions. This ensures that there are fewer opportunities for error and you save space and weight. After bunkering, the water can still be become contaminated in the tank, especially if consumption is low and the water consequently stays on board for a long time.

In summary it can be said that the following two solutions represent the most efficient solutions:

- Large tanks and large flow rates:
A large ceramic and activated carbon filter, or a cartridge that combines both

Vehicle procurement

- Small tank and small flow rates (separate drinking water tank): Disinfection device in the tank and small activated carbon filter just before the drinking water tap.

In both installation cases, coarse filters should be installed after the tank, but before the pump and fine-filter.

Treating the drinking water by adding disinfectant chemicals is not recommended for the daily water consumption on a long journey, but at best makes sense on a trek on foot, or when traveling by motorbike or bicycle.

Grey Water

If you want to use the on-board water in cities, campsites or parking lots, you will need a waste water tank. It does not have to be very large; 20-30 l are usually enough for a day or two. Grey water, i.e. dishwashing and shower water, as well as the water from the sink in general, is only slightly contaminated and, in an emergency, small quantities can be disposed of in the bush or, where available, in the sewage system. This becomes increasingly difficult with large tanks of a truck. In most countries outside of Europe and North America, disposal stations are not easy to find, if at all.

A bucket or collection tank under the outlet can serve as an emergency solution, but this water must also be disposed of somehow afterwards.

Black Water

This topic is even more important for black water (toilet waste water). The only practical solution on a trip around the world are the cassette toilets that are common in RV's. The tanks are handy and can also be emptied into a normal toilet in an emergency. Meanwhile, toilet chemical products that are less harmful to the environment are also on the market. You should pay particular attention to this when you are traveling in regions where proper sewage disposal cannot be guaranteed. Otherwise there are fundamental alternatives which are explained below.

Vehicle procurement

Toilet Systems

SOG System

Environmentally friendly emptying of the toilet cassette into a normal toilet means that there should be no harmful chemicals in the black water. Under no circumstances should you empty chemically contaminated black water into nature or even into a toilet that is not connected to a regular sewage treatment plant, because the toilet additives destroy the bacteria that are necessary for the biological purification of the wastewater.

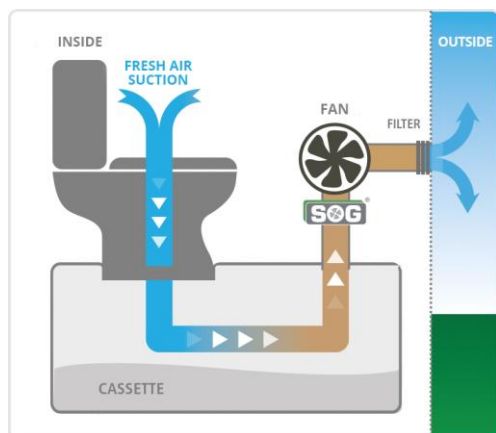

Figure 37 SOG Function principle
(source: sog-systeme.de)

If a toilet facility is equipped with a [SOG system](#), no chemicals are necessary and the black water is less harmful to the environment. During use, fresh air is sucked in with a small blower and conveyed outside through the toilet cassette. Another advantage is that the "business" can be done without unpleasant odours in the vehicle. The faeces and normal toilet paper decompose quickly and largely odourless even without chemicals. The system is highly recommended. Only when it is very warm should you empty the cassette with a SOG system after 2-3 days at the latest to avoid unpleasant odours.

HINT

If you are driving on bumpy roads, you should empty the toilet cassette before it's used to the full capacity to avoid spillover.

Vehicle procurement

A normal cassette toilet is flushed with water after use, just like the toilet at home. Of course, this means the toilet also uses its share of water. The space requirement, including the cassette, also makes it somewhat difficult to install a toilet in a small vehicle.



Figure 38 Portable toilet (source: <https://www.thetford-europe.com>)

As an alternative, there is also a portable mini design. However, this does not work without chemicals and the tank is relatively small, so that it has to be emptied quite often. But especially when wild camping is only allowed with a toilet on board, this can be an acceptable solution.

Separating Toilet

A good and increasingly popular alternative is a urine-diverting toilet. The urine is collected in a separate tank and the solids fall into its own container where the moisture is absorbed with organic material. While the urine tank has to be emptied every few days, it takes much longer to fill the solids container.

The advantages are: no water consumption, disposal in the normal garbage, respectively toilet, is possible and no chemicals necessary.

Disadvantage: A bit more cumbersome to handle and the need for absorbing material, which must be procured and carried along.

Installing a composting toilet is easier, especially if you do it yourself, provided you have the space. On the one hand, you don't need a water connection nor a cassette installed underneath the toilet. Furthermore, a power connection is only necessary if you opt for a ventilated solution.

Meanwhile, this type of toilet can be installed at the factory, however mostly only on special request. Even mobile solutions are available on the market, so that there is also an option in smaller vehicles.

Vehicle procurement

When making your selection, it is important to ensure that the urine tank is large enough, especially if several people are traveling with you, otherwise the tank may have to be emptied every day. You calculate with approx. 1-2 l tank volume per day and person. The same applies to the solids container. With a volume of 30 l being sufficient for two adults for around a week or more of regular use. Any organic and absorbent material can be used as an absorber, from commercially available, compact coconut bricks to sawdust. Wood shavings and sawdust can be found worldwide and are also ideally suited. After the "business", cover the faeces with a handful of absorbing agent unless the toilet model is equipped with a mechanical mixer.



*Figure 39 Separation toilet; Tiny from Separett
(source <https://separett.com/de/trenntoilette-tiny-mit-urinkanister>)*

Incineration Toilet

In and of itself a "clean affair", because after going to the toilet, the "business" is burned to ashes in a combustion chamber. This creates dry residues with a small volume. The toilet can therefore be used up to 70 times before the ashes have to be disposed of. Unfortunately, this system also has its disadvantages. For example, more than 100 g of gas is used per combustion, which takes about an hour, and the products are quite expensive. An exhaust chimney must also be installed. In summary, probably more suitable for trucks. If the system breaks down en-route, it will be difficult to fix it, and improvised use is also not possible. The purchase price is also in the upper price segment. With all these disadvantages, this type is therefore a rather exotic solution in the camper sector.

Vehicle procurement

Electrical System

This is a very big topic and there are probably as many opinions/solutions as there are people. Basically, the thought is worthwhile here too: as simple as necessary. You have to keep in mind that if you want to travel in less developed countries and you are not an electrical specialist, malfunctions can cause quite a headache. A complex system not only contains more sources of error, but it will also be difficult to obtain spare parts and expertise for it.

Battery

In the design and performance of the system, the focus is on in which region and climate you want to be self-sufficient, and for how long. To do this, you have to be aware of how much energy all electrical consumer combined use in a 24-hour cycle. If you multiply this value by the number of days you want to be self-sufficient, you get the minimum battery capacity you need. With a solar system, this period of time can be extended as desired with the appropriate design. More on that later.

Lithium Battery

Lithium batteries are becoming increasingly popular. The advantages compared to lead-acid batteries are obvious: lower weight, maintenance-free, longer service life (number of discharge cycles), high charging and discharging currents possible. On the other hand, there are the following disadvantages: more expensive to buy, special charging characteristics required if there is no built-in battery management, charging at very low temperatures is restricted, replacement in developing countries is still rather difficult.

WARNING

A relatively new issue are the rules of more and more shipping companies which prohibit the transport of Lithium batteries onboard of RoRo vessels. You might be able to sneak the battery onboard but then you might be held responsible in case of a problem. And if you are caught at the harbour you will be denied boarding! So be sure, and honest, to discuss this point with the shipping agency.

Vehicle procurement

If you can ship in a container, this problem is reduced. Worst case you have to pay a surcharge for the transport of "dangerous goods" but there should be no problem accepting your vehicle.

Lead Battery

Lead-acid batteries have a more limited lifespan. This is often calculated in "cycles", on average are around 500 cycles. A complete discharge and recharge corresponds to one cycle, i.e. 2 years of continuous use and the service life is reached. The battery is not defective after this, but the capacity decreases noticeably. For this reason alone, it is worth sizing the battery capacity generously so that it is only discharged to a small extent overnight. This corresponds to only one "partial cycle" and thus the life expectancy can be increased. It is important to understand that a lead-acid battery may only be discharged to about 50% of the nominal capacity due to its construction, otherwise there is a risk of a reduction in service life or even a defect. In normal operation, the battery should ideally only be discharged to around 80% of its nominal capacity overnight.

It is advantageous, if possible, to install only one big battery with the required capacity for the system. This has advantages in use, because if one of several batteries should fail, there is a risk that the other batteries in the same circuit will also be destroyed. If absolutely necessary, at least models of the same size and type should be interconnected.

Solar System

A solar system must always be designed large enough that the battery capacity that has been discharged overnight can be replaced and the daily consumption can also be covered. It plays a decisive role in which area and season you will be traveling. On cold, short winter days you will only achieve a fraction of the summer solar output and at the same time have a significantly higher consumption. Additionally in the tropics you have less yield because it is often overcast and the days are always short. Remember that the fridge will run almost constantly in the heat.

Vehicle procurement

If lead-acid batteries are installed, it is advantageous to size the solar power as generously as possible. The reason is the charging characteristic, because this requires a long charging time and all the more so than when charging with small charging currents; it is also advantageous with Lithium batteries if you can deliver large currents, especially at the beginning of the charging process. This leaves enough time to charge the battery as completely as possible, even on short days.

Here is a [>LINK<](#) to an EXCEL tool with which you can size a solar system including battery size or check an existing installation.



Abbildung 1 Mobiles Solarpanel (underway.ch)

An additional, mobile solar panel has the great advantage that the vehicle can be parked in the shade and the battery can still be charged via the remotely placed solar panel. Furthermore, you can support the roof system when the sun power is weak.

The solar panel will be feeding in parallel to the roof system, so the controller should have a corresponding power reserve. In this context, it is important that the nominal voltages of the two solar systems are approximately the same, otherwise two separate solar controllers must be used.

Which type of solar panel should be installed for the roof system depends on the following factors:

- Price
- Available area
- Surface shape of the roof

A basic distinction is made between flexible and rigid panels.

Vehicle procurement

Flexible Solar Panel

This design enables light, thin and therefore flexible panels. They are ideal when they are to be installed on an uneven roof. In addition, they



Figure 40 Flexible solar panel, installed with ventilation (underway.ch)

are not bulky and do not protrude. Since panels in the sun heat up and thus lose some of their performance, it is ideal to bond the panels to an aluminium sheet and attach this to the roof with some space underneath for ventilation. If you choose this type of installation, you must avoid stepping on the solar panels! If you favour this panel type, it is worth choosing a proven and high-quality product. Cheap products and poorly assembled panels can be more prone to failure.

Monocrystalline Panel in Aluminium Frame



Figure 41 Rigid mono-crystalline panel
(source: <https://ousuca.com/camping-solaranlage-kaufen/>)

Monocrystalline panels are about half the price, but have the disadvantage that they are about 3 cm high and heavier. Ideally, this type of construction should also be mounted with rear ventilation, so this installation adds some extra height. Even if this design is quite robust, they cannot be walked on and protrude noticeably more, which increases the risk of damage.

In terms of efficiency, both types are roughly comparable. More likely, there are striking differences among the various providers. Before you decide on the cheapest offer, you should gather experiences from existing customers.

Orientation towards the sun has a noticeable effect on efficiency. In winter, when the sun is rather low, the solar system mounted horizon-

Vehicle procurement

tally on the roof will generate significantly less yield than if the panels can be aligned as optimally as possible, i.e. at right angle to the sun. If the camper has a pop-up roof and this can be aligned to the sun, you already gain measurable performance.

Solar Controller

The so-called MPPT solar controllers have become standard on the market for several years. Although they are a bit more expensive than simpler controllers, they are definitely affordable and the additional power when charging is noticeable.

When making the selection, it must be ensured that the charging capacity matches the installed solar system and offers spare capacity for a possible expansion later. Depending on the model and manufacturer, a display unit is either included or available as an accessory. Alternatively, there are also products on the market that can be coupled with a free app and then statistics can be displayed in addition to the current values.

A recognized good manufacturer with a wide range of products is [Victron Energy](#).

When wiring the solar system from the panel to the battery, it is important to ensure that the cable cross-sections are generously dimensioned in order to minimize voltage and thus power losses. Correct fuse protection of the circuits is also important so that no consequential damage or even a fire can occur in the event of a fault.

Charge Booster

When driving, starter and camper batteries can also be charged with the vehicle's alternator. A so-called charging booster makes it possible to optimize and fully charge different battery types. In modern vehicles, this is usually absolutely necessary, otherwise the alternator will be switched off automatically as soon as the starter battery is full, while the camper battery should still be charged.

Vehicle procurement

Isolating Relay and Battery Monitor

To prevent the starter battery from being unintentionally discharged when camping, a cut-off relay is usually installed. This disconnects the starter and camper battery as soon as the ignition is switched off.

In addition to the actual relay, it makes sense to use a suitable control unit. This takes on additional, useful tasks. For example, if a solar system is installed, the controller reconnects the batteries so that the starter battery is also charged if it discharges over a longer period without use (winter storage!).



Figure 42 Display of IBS Battery managers (source: <http://ibs-tech.ch/produkte/doppel-batterie-system.html>)

Depending on the controller, it is also possible to manually couple the two batteries temporarily. This function can help you out of a jam if the starter battery is defective or discharged, because in this case you can also operate the starter with the camper battery. This also works if the camper battery fails, but in this case you have to maintain the remaining starter battery capacity sufficient to start the engine. But at least you can keep the beer cold despite a failed camper battery.

The coupling of both batteries can also be helpful when a recovery winch is engaged, because the additional power from the camper battery can significantly relieve the load on the starter battery.

The [Swiss company IBS](#) supplies proven products. Depending on the application, different models and components are available. The display module also shows the state of charge of the two batteries.

Shore Power

If you decide to also install a shore power connection, you must ensure that the input is correctly fused and a priority circuit ensures that after connection to the mains, any 230 V sockets are only supplied by the shore power and not also by the inverter.

Vehicle procurement

In many countries, electricity hook-ups in campsites are usually not very efficient. They are often only fused to just 6 A, therefore you can draw a maximum of 1500 W. So when connecting a coffee machine, hair dryer and air conditioning system, the fuse of the supply line or even the entire campsite can sometimes blow.

You should also note that there are countries with 115 V mains voltage. Apart from the different plug types, there is the problem that the directly fed sockets would only be usable for certain devices. The most universal solution is to install a broadband battery charger and draw 230 V from an appropriately powerful inverter. See also the following chapters.

Alternatively, you can also install a 115 - 230 V transformer upstream. However, these are quite large and heavy and therefore make more sense if you plan to spend a longer time in a 115 V region and really depend on shore power. A long-distance travel vehicle equipped with a high-performance solar system does not normally need a shore power connection at all.

Alternative Power Supply

In addition to the usual methods already mentioned, you can also consider a generator or a fuel cell system for supply.

The former has the disadvantage that it causes noise, which is particularly annoying for camp neighbours, and is therefore prohibited in most campsites. A generator can be permanently installed in the vehicle and equipped with an automatic start at the push of a button. Alternatively, a portable model is used with the advantage of being able to place the device away from the vehicle. Overall, however, a generator requires space, fuel and is correspondingly heavy. As a rule, however, generators are mainly used in large vehicles.

Although fuel cells are almost silent, they are (still) quite expensive to buy. The used fuel is also usually "exotic" (methanol or gas) and correspondingly expensive and difficult to obtain depending on where you are on the road.

Vehicle procurement

Power Inverter

If you have no shore power and still need 115/230 VAC on board, an inverter must be installed. This converts the battery voltage to mains voltage. The maximum currents in the 12V network can quickly become large. For example, if you want to operate a coffee machine from the battery, it easily needs 1500 W. Accounting for additional power reserve, the inverter must therefore be able to deliver 2000 W. This in turn means that the current from a 12 V battery will be $(2000 \text{ W} / 12 \text{ V} =)$ 170 A! Not only is a battery with insufficient capacity quickly drained, the cable cross-section must also be designed accordingly in order to avoid losses and overheating of the cable.

Here you can calculate cable sizes using the [>LINK<](#)

If you want to set up the entire system yourself, you should research carefully, especially if you lack the necessary specialist knowledge and experience.

Gas-free Installation

A growing trend is to build camping vehicles without any gas on board. In this way, the following disadvantages can be avoided:

Vehicle Shipping

When it comes to shipping, it is becoming increasingly difficult to transport vehicles with gas cylinders or permanently installed gas tanks. Even an expensive nitrogen flushing of empty tanks is no longer always acceptable. While you can leave the bottles behind to get local bottles at your destination, this is not possible with permanently installed tanks. However, local cylinders also require appropriate adapters or adaptations to the existing gas installation.

But then, Lithium batteries suffer transport restrictions too, as explained above.

Gas Procurement

The recurring filling of the tanks/bottles on a trip around the world is always a challenge. Be it local regulations that prohibit the filling of

Vehicle procurement

foreign containers or the different connections on the filling fittings, refueling can become an adventure.

Gas Free Alternative

It is precisely these disadvantages that can be eliminated if you can do without gas. However, this also means that gas energy must be replaced by electrical energy. This, in turn, means that the performance of the electrical equipment must be generous. A calculation of future consumption should be the basis of the design. (see chapter [«Electrical system»](#))

If you switch the heating or the refrigerator from gas to diesel resp. electricity, it will be less of a problem. If, on the other hand, you also want to cook electrically, the demand, and especially the flowing current, increases considerably. To operate one induction field (approx. 2000 W) for one hour per day, a solar system with a maximum power of 500 W must deliver more than 4 hours flat out! This is not possible on a winter's day, even with a bright blue sky. The battery will drain a whopping 150 Ah, just for the one hour cooking. And then all other consumers have to be served too.

In general, it can be said that this concept is more suitable for trucks, because they usually have large enough roof areas for the solar system and enough space and payload for the necessary battery capacities and inverters. If you want to equip a 3.5 t vehicle accordingly, you will probably not be able to avoid making compromises when cooking. By the way, an espresso machine basically needs a lot of power, but usually only a few minutes. This means that large currents flow during operation, but not for very long. So if you don't drink a lot of coffee every day, it won't put an excessive strain on the battery capacity. Example: Two cups of coffee, including the warm-up phase, will consume electricity for about 10 minutes at 1500 W. This corresponds to about 20 Ah battery capacity. In order to replace it, the above example solar system needs about 2 hours in the best case.

However, if you are prepared to cook primarily outdoors, for example on a gasoline stove, you can significantly reduce your energy require-

Vehicle procurement

ments. On the author's travels, this is basically the case and only for morning coffee and in bad weather the permanently installed gas stove is used. Then, for example, a 3 kg gas cylinder usually lasts for over 4 months. The vehicle has not been connected to shore power since the installation of a 90 Ah lithium battery. But even so, the 125 plus 100 W solar panels are only sufficient to remain self-sufficient for several days in late autumn, even when the weather is nice, and only just barely.

On the basis of these explanations, it should be clear how important the needs assessment and the resulting installation design are. If you're wrong, you may end up having to prepare your soup outside on the emergency cooker, despite the elegant super truck you travel with.

Electrical Installation

When laying electrical cables, generous cross-sections should be used to minimize voltage losses. Cross-sections that are too small lead to overheating of the cable and, in the worst case, to a cable fire. For this purpose, the individual cable conductors should be correctly fused on the battery side. This is important when building a vehicle yourself, but you should also check it when buying, as people like to save cost and labour at this point.

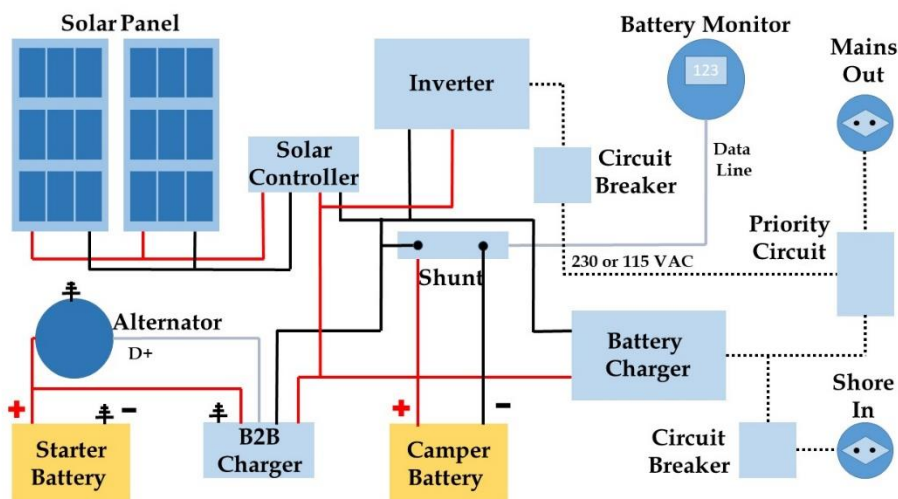

Figure 43 General electric schematic of an overlanding vehicle

Vehicle procurement

When placing the individual electrical components, care should be taken to ensure that they remain accessible for maintenance and repairs even after completion. However, they should also be installed in a location that is not used as premium storage space. Furthermore it must also be taken into account that components between which large currents flow are installed as close together as possible. Typical of this are alternators, solar systems (especially for outputs >500 W), batteries and inverters.

A major shortcoming with purchased vehicles is the mostly missing wiring diagram. This makes it difficult to track down sources of error and carry out appropriate repairs. Since many circuits should correctly be fused separately, it is also important to know where the fuses are located. Another problem is that it is often not clear what has been laid where and even if this is known, it does not mean that one has easy access to the wiring.

It is therefore advisable to get to know the complete electrical system before departure and, if necessary, to document it. This includes a schematic diagram and ideally also the labelling of the individual connections and plug contacts. The effort involved will be appreciated if problems should arise on the trip, something which, by the way, is one of the most common defects on long journeys. Main issues are not defects but bad contacts and ground connections.

Cabin Design

Classic standard motorhomes are not explicitly dealt with here, although you can travel to many travel regions with one. However, you should then choose a high-quality model, since many of the cheaper vehicles are not designed for long-term use. On extended trips, especially outside of Europe and North America, you cannot always count on good road quality; bumpy roads and pothole-paved roads are a challenge for classic motorhomes, not even talking about rough gravel roads. In particular, the furniture and its fittings suffer. In addition, this type of camper offers few options to make it "suitable for self-sufficient long-distance travel". As already mentioned, this does not

Vehicle procurement

mean that you cannot undertake a long-distance journey, but the choice of route will possibly need to be adapted. However, bad roads can never be completely avoided, especially if you would like to move off the main routes and roads.

There are several classic designs for living cabins. If you choose a full size truck, a box-shape results almost automatically. This container-like structure sits flexibly on the chassis and can include access to the driver's cab from the back of the truck. Bodies with alcoves are less common.

For vehicles in the <3.5 t class or just above, there are already more variants:

Van and Off-Road Vehicle

This type uses the original body of the vehicle for the set-up. If you want standing height, a high-roof variant is selected for a van. Depending on the model, there are also several options for wheelbases, from short and compact to very long.



Figure 44 4x4 van with pop-up roof (underway.ch)

The often compact dimensions and the inexpensive possibility of self-build are advantageous. Installing a pop-up roof allows standing height too even with a standard height model.

If you also want to travel away from the good paved roads of Central Europe, you should make sure that you have robust (off-road) tires with the largest possible dimensions (diameter, not width), as well as plenty of ground clearance and little overhang on the rear axle.

If the vehicle is less than 2.5 m overall height, it can be shipped in a Hicube container! You have to keep an eye on the overall weight with

Vehicle procurement

this design. Small vans in particular often have little payload from the start, while e.g. Mercedes Sprinters also offer higher gross weight versions.

Meanwhile, several panel van models are also available with all-wheel drive. However, it is important to remember that the main limitation is not the lack of traction, but rather the lack of robustness of the chassis, especially the tires, and the lack of ground clearance. So you should always check whether off-road tires and a body lift is possible.



Figure 45 Landrover based camper (underway.ch)

Even large off-road vehicles such as Land Rover, Toyota Landcruiser or long wheelbase Mercedes G can be converted into a camper using this concept. However, the space available will remain quite cramped even with a pop-up roof. But you would have a robust and compact vehicle, which also

allows travel off-roads.

Pick-Up Camper



Figure 46 Pick-up camper (source: Gillfoto, CC BY-SA 4.0 <<https://creativecommons.org/licenses/by-sa/4.0/>>, via Wikimedia Commons)

This is an off-road vehicle on whose tray a camper cabin can be placed. Since the loading area is already quite high above ground, the overall height, as well as the centre of gravity, will be elevated. In addition, the space available is usually limited, unless you opt for one of the American pick-up

models. There are also cabins with a pop-up roof (see picture), which somewhat reduces the disadvantages mentioned.

Vehicle procurement

Instead of placing the cab on the tray, you can also remove it and mount the cab onto the chassis using a sub frame. This gives you extra space and saves weight and height. In addition, the entire width of the vehicle, or even more, can be used. However, the cabin can no longer be set down quickly.

Experiences of travellers with this type of cabin have shown, that chassis fractures occur quite often in pick-up vehicles that are not sufficiently robust (Nissan, Mazda, Mitsubishi, etc.). This seems to be due to the fact that the high and often heavy cabs cause strong pitching movements and thus longitudinal twisting on bad roads and tracks, which subsequently leads to the chassis, which was not designed for this, being overstressed. The problem is all the greater when the cab is high and heavy. Alcove designs are most critical and so are double cab pickups, there because the centre of gravity of the cabin is too far back.

Vehicles like the Land Rover, Mercedes G and Landcruiser are not affected simply because they are designed to take heavier loads.

Good read about the topic: [>LINK<](#), or google “broken chassis on pickup” for lots of pictures!

Partly Integrated Camper

This is very popular with motorhomes, but you can also do it on off-road vehicles and vans. From the carrier vehicle, only the chassis and the driver's cab are then used. Behind the cab, the body structure is connected to the chassis and also to the driver's cab either fixed to the



Figure 47 Partly integrated camper ([underway.ch](#))

body floor or by means of an auxiliary frame. The advantage is that you can build a slightly wider and higher cabin. This significantly improves the sense of space and the interior dimensions. If you want to remain under 3.5 t, the weight must be kept as low as possible during the build. Many of

Vehicle procurement

these types are often massively overloaded when they set off, as they only allow a small official payload. Most models can be specified to a higher gross weight, but the weight remains and this has a noticeable effect on off-road capability. In addition, the usual disadvantages of the >3.5 t class come into play. Above all, alcove cabins with permanent headroom can quickly become three or more meters high and are often relatively heavy, which is certainly not an advantage.

Base Vehicle

The weight and the overall dimensions are very decisive influencing factors on the overall project. If it is large and therefore inevitably heavy, this almost automatically rules out a vehicle in the 3.5 t category. In order to avoid having to get a truck driver's license, you can try to at least stay in the 7.5 t class, which is known in some countries. However, this reduces the available carrier vehicle models and the remaining payload may already be minimized again. It also has drastic influences on the shipping options.

On the other hand, there are of course completely different opportunities in terms of autonomy, payload and comfort. For this reason, one should first be clear about this before deciding on a model. See also chapter ["Trucks"](#)

Dimensions

There is one important dimension in the basic decision about the desired vehicle: the overall height. If this is more than 2.5 m, shipping in a closed container is not possible. Depending on the planned itinerary, this can mean a significant reduction in transport options, an increased risk of burglary during shipment or a major cost factor.



If no container shipping is planned, the height plays less of a role, even though vehicles built too high are repeatedly confronted with problems such as low-hanging cables, low

Figure 48 Shipping in a hi-cube container
(underway.ch)

Vehicle procurement

access roads or bridges and tunnels with height restrictions.

A length > 6m restricts parking on normal parking spaces and such campers are often significantly more expensive on ferries. A short overhang is also important, which reduces the risk of bottoming out and the damage associated with ramps and when driving through dips.

The maximum width can also be quite restrictive on narrow mountain roads. However, if buses and trucks also use the same routes, this is less of a problem. The restrictions are more likely passageways in old European city centres, which are often not designed for large vehicles.

Gross Weight

You have to decide whether you want to stay in the <3.5 t category or go beyond it.

In many countries, additional restrictions and rules apply to vehicles over 3.5 t. Road tolls and transport costs on ferries are usually significantly more expensive. On the other hand, it is an advantage that you usually have more payload and can therefore build larger and have to pay less attention to the weight. Depending on how heavy the vehicle is, a truck driver's license might have to be obtained.

Consider the fact that there are more Overlander who have switched from large to smaller vehicles than vice-versa.

Base Model

If you stay on paved roads in well-developed countries, the question of the base vehicle is less important. On a route off the main roads and in less developed regions it is a great advantage to have at least a sturdy vehicle with good ground clearance. In this case, it is also advantageous not to choose a model that is too modern, since such vehicles often use technology that is difficult or impossible to repair under difficult conditions. This is particularly important in less developed countries or wherever the particular model has not been sold.

Vehicle procurement

4x4?

Does it have to be a 4x4? Yes and no, but even if you're not necessarily looking for "hard core" off-road routes on your journey, an off-road vehicle offers additional security, for example if the road conditions deteriorate surprisingly, be it because of rain and snow or because the road maps are too bad and don't reveal the actual road conditions.



Figure 49 Bush camping on a beach (underway.ch)

The "last 200 m to the dream place to stay on the beach" are often inaccessible for non-off-road or large vehicles. Compared to "normal" vehicles, off-road vehicles are above all more robust, have more ground clearance and are

equipped with robust tyres, an advantage that should not be underestimated.

The better traction of an all-wheel drive vehicle is not the decisive argument for opting for it, even if it opens up additional possibilities in many cases and, above all, offers greater safety and flexibility.

Fuel

Depending on the visited region, you might have to reckon with poor fuel quality, something that modern engines tend to have problems with. The same applies to very high altitudes such as in the Andes and other high mountain areas. Modern engines are optimized up to approx. 2500 m above sea level, above that, the standard engine management works less optimally and in the worst case it leads to clogging of the particle filter and the engine only runs, if at all, in the emergency mode.

Vehicle procurement

Another "diesel problem" can arise in regions where fuel with Euro-diesel sulphur content is not available. Modern engines cannot cope with high sulphur content, or only with restrictions, so it is also important to clarify in advance whether the planned travel region is affected and whether the desired vehicle would be able to cope with it. The same applies to the availability of AdBlue, even if it is becoming more and more available, at least in large cities, even in less developed countries.



Figure 50 In over 5000 masl; Andes of Peru (underway.ch)

Before making a decision, it is worth consulting the relevant specialist forums to see where problems can be expected and how they can be solved.

A fuel pre-filter can be installed as a preventive measure to prevent main fuel filters from being clogged by dirty fuel. If the fuel is heavily soiled, it will catch most of the dirt and relieve the finer main filter.

Petrol or Diesel?

Well, diesel clearly has its advantages. The fuel is usually cheaper, less flammable and the consumption is lower at the same time, a considerable advantage for the travel budget. Also, diesel is at least as readily available as petrol, with a few exceptions, e.g. in the Middle East and some Stan countries. The reduced consumption also has a positive effect on the range, an important argument depending on the travel route. Very cold temperatures can pose a problem for diesel fuel (including the auxiliary heating that is operated with it), especially if you have not filled up with winter diesel. Below -25°C , without heated tanks, filters and lines, a limit is usually reached where the fuel "gels"

Vehicle procurement

and can no longer be pumped. Summer fuel can be made suitable for winter with the appropriate additives, the product takes up little space and can be taken on board at the beginning of the journey if necessary.

However, most travellers will try to avoid very cold temperatures, so the problem is usually not relevant, but if you want to admire the aurora borealis in the polar region, you have to take the appropriate precautions. But this also applies to water/wastewater, electricity requirements and heating.

Vintage Models

A very old vehicle is only recommended for people with good vehicle knowledge and those who can also lend a hand. On the other side, these models are usually equipped with technology that is easier to repair in the bush. Well-preserved models from around 1990-2010 are ideal. These vintages represent a good compromise between engine performance, repair ability, price, comfort, lower fuel consumption, the availability of spare parts and reliability.



Figure 51 Vintage Mercedes truck camper (source: pistenkuh.de)

Trucks

If you choose a truck, you have to be aware that running and maintaining it will be quite a fair bit more expensive than that of a 3.5 ton vehicle. Fuel consumption can easily be twice as high. Tires are also a lot more expensive, and off-road tires, in particular, are often difficult to procure on the trip. Operating resources such as oils are also more expensive because the quantities required are usually much larger. In addition, spare parts usually cost a lot more.

Vehicle procurement



Figure 52 Truck Camper (source: Chris Hunkeler from Carlsbad, California, USA, CC BY-SA 2.0)

Especially if you plan to unwind many kilometres per year, 50'000 km are not uncommon depending on the route and the time available, these costs can make a big difference. On the other hand, if you travel very slowly, i.e. small distances per year, these arguments are a lesser issue.

In any case, trucks are also more durable and much more robust. Therefore, an older vehicle with a lot of mileage can still be considered.

Buy New or Used or Just Build it Yourself?

A difficult question. However, certain variants cannot be built by yourself, therefore buying is the only option. But, do you actually find what you are looking for? Can you afford a brand new vehicle? Do you have the skills and time to do the build it yourself? How long is the delivery time for a new vehicle?

Lots of questions and no general answer. But it certainly makes sense to start looking for a vehicle as early as possible and try to do a test trip of at least a few weeks before the big journey. There is probably nothing worse than when you are finally on the road, the problems are piling up right from the start and thus your nerves and travel budget are overly strained.

It's no different when you build something unique yourself or have it built. Some things may not work or fail if you dare to tackle such a project without any experience. Even professional companies do not always have the necessary expertise in all areas. It is all the more important to get references in advance, e.g. at the annual trade fair "Abenteuer Allrad" in Bad Kissingen (Germany) or similar. You

Vehicle procurement



Figure 53 Bush mechanic in Mexico (underway.ch)

If you buy a finished vehicle, it is a great advantage if you also know the details of the construction. Where are the wires and cables laid? Where are the fuses? Which components (electrical, water, gas) are installed and are their operating instructions and spare parts known?

In general, you should make sure that you understand the built-in technology to some extent and, at best, can also check and repair it, because in most countries without a "camping infrastructure" there are few specialists and often no material to work on a complex world tour vehicle.

Pollution Category

A problem that is becoming more and more widespread is the low-emission zones that have been introduced, especially in Europe. Vehicles that do not belong to the latest Euro classes are increasingly excluded from city centres. Violations are sometimes punished with expensive fines. The whole concept of these environmental zones is very complicated and very difficult to know all the many standards and regulations



Figure 54 Many different pollution zone sticker in Europe (<https://www.green-zones.eu/def>)

Vehicle procurement

for Overlander who visit several countries.

To get an overview of the current restrictions, the following website can be consulted: [>LINK<](#)

The dilemma now is that people travelling on other continents would rather not want a vehicle that is too modern, while on the other hand in Europe older models are increasingly restricted and “punished”. So it is important to decide before buying which toad you want to swallow.

Buying a Vehicle away from Home

To avoid expensive shipping to the start of a planned trip, one might consider buying the vehicle abroad.

This is something quite a lot of overlander decide to do, but!

In many countries it is difficult if not impossible to register the purchased vehicle in the new owners name. Some countries would not allow to leave the country without formalities and restrictions. If the registration is running out it is not always easy to renew it.

There are ways to prevent any bureaucratic hurdles by buying the car from another traveler. But again, there are some obstacles and restrictions. In many cases it is possible to leave the registration running on the previous owner. In this case you must carry a document that permits you to drive the car of the official owner. In South America this document is called “poder”. It need to be issued and stamped by a lawyer. But even so, it is not guaranteed to cross all borders without any hiccups. Furthermore, if you plan to go down this road, be aware that if you want to get rid of the vehicle at the end of the trip you, respectively the new owner, might stuck with the paperwork. The reason is that you cannot just hand over the “poder” to the next owner because the still official owner only can do this.

Another complication is, that it is often impossible to renew the registration away from the country of origine and definitely not for you not being the official owner.

Vehicle procurement

So, as you can see, buying the vehicle is the least problem, but leaving the country, selling and reregistering it might well be one. Yet another point to consider and keep in mind is that if the previous owner is a foreign traveler too, he has entered the country under a TIP (Temporary Import Permit) thus you will take over this permit and finally leave the country instead of him. This also can rise discussions or more at the border.

A few questions to be answered before you buy:

- Can the registration documents and ownership formally transferred to another owner (maybe also if you are a foreigner and the vehicle is outside the country of origin)?
- Is it sufficient for crossing the planned border by leaving the paperwork in the name of the official owner and have a written and formalized document to state the permission for you to drive it?
- Is renewal of the registration possible from abroad?
- How can the paperwork be handled when the car is again up for sale?

Since the rules are different in any country it is impossible to provide a general process for a purchase of a vehicle from a foreigner or a vehicle sold by a local with local registration. But you have to be careful to understand the risks and rules if you want to avoid problem in the future.

In Europe for example it is quite difficult if not impossible to register a vehicle in your name without residency. In the US this is usually not a problem and some states allow even reregistration and transfer ownership formally correct from abroad. In South America it is quite common to sell/buy vehicles between travelers, very popular to do this is Chile.

Selling the vehicle on any local market away from the country of registration is often impossible or the duties and fees involved are extremely high. You can't even give it away for free, because you have most

Vehicle procurement

likely entered the country under a TIP. If the custom authorities find out you will have to pay the duties anyway.

And last but not least: Buying from another traveler carries the risk that there might be a lack of maintenance and/or hidden faults, because why would one want to spend in a lot of preventive maintenance knowing that the car is going to be sold after the trip anyway. An unreliable vehicle can cause a fair bit of headache, time loss and cost.

If you still consider buying abroad, make sure you investigate thoroughly how this has to be tackled and what the prices and offers in the target market look like.

Preparation



Preparation

Once the plan has matured, concrete preparations begin. If the vehicle already exists, a few months will do. In order to move forward reasonably efficiently and not forgetting important things, it is best to create a checklist. For this purpose, the individual points of the following chapter can be used as a common thread. Next you have to set a reasonable end date and an estimated duration for each activity. In order to determine the start, set the desired end date of the activity and count back to determine when to start latest. But beware: Not everything can be processed in parallel and some spare time should also be built in, otherwise it quickly becomes stressful, an experience that most people have.

Vehicle

Before you start, it is advisable to do, or have done, a major maintenance. Anything that needs to be changed as a preventive measure over the planned travel distance should, if it makes sense, be changed before departure. This applies in particular to upcoming timing belt replacement and injector change in older diesel engines. The exchanged parts can be carried along as spare parts for emergencies on the journey. Of course, this is not necessary if the route leads through an area where your vehicle model is well known and where this work can be carried out even more cheaply and without problems. The more exotic the model and the less you can do on the vehicle yourself, the more important it is to do as much preventative work as possible. The fact that the vehicle should always be in good technical condition when you leave seems logical, and will certainly save you a lot of stress, costs, and trouble on the road.

Preparation

Vehicle Equipment

In addition to the topics below, it is recommended to obtain detailed information about the planned route and the vehicle used. This is the only way to determine the relevance for your own case.

Mandatory Vehicle Equipment

In most countries it is mandatory to carry certain equipment in the vehicle. The following items are the most common:

- Fire extinguisher
- Emergency first-aid kit
- Warning triangle(s)
- Safety (high visibility) vest(s)
- Tow rope
- Snow chains (usually only seasonal)

However, since the requirements (the standard and the required number of pieces of equipment) are inconsistent, these requirements can hardly be fully met on a trip around the world. Unfortunately, in countries where corruption is widespread among authorities, this is often exploited and attempts are made to “fine” travellers. It is also not uncommon for such police officer to spontaneously and creatively invent things that do not correspond to any legal basis. However, many police officers are rather generous and understanding towards travellers, so that problems usually don’t arise.

It is best to take the items listed above with you as a precautionary measure, although two items are recommended: warning triangles and safety vests, but snow chains are not absolutely necessary. Otherwise, a good mixture of naïve ignorance, friendliness and respect towards the officer usually helps at check-points. See also [“Check-Points”](#).

Accessories

If the vehicle has already been tried and tested, this chapter will have little meaning. Nevertheless, it makes sense to use the information below to check whether everything has already been thought of.

Preparation

Vehicle accessories are very popular, especially for off-road vehicles, and in some cases they also make sense. It must be clear that the driving style on a long journey will be more defensive in terms of driving technique. This means off-road routes with a high potential for wear and damage will be the exception, unless that's the focus of the trip.

A good jack is a must. You should therefore try the original jack to see how and whether it works. A stable base plate definitely needs to be part of it, in case the car has to be lifted on soft ground.



Figure 55 Hilift Jack in Aktion (underway.ch)

The popular and cool Hi-Lift Jacks can be used quite universally, but they also have some major disadvantages: They are heavy as lead and bulky, they cannot usually be used on modern vehicles, and handling the jack them must be mastered, otherwise it gets really dangerous. The advantage, provided you have the appropriate expertise and practice,

is that the Hi-Lift Jack can also be used as a winch and as tool for the rough stuff. A balloon jack, which works with the exhaust gas pressure, can also be used to change a wheel and free the stuck vehicle. But it has to be handled carefully, otherwise it will be damaged and it must never be used under the car without additional support to change a wheel or during repairs.

Additional headlights are not absolutely necessary, especially since driving in the dark is a "no go" in most countries for safety reasons, but if it cannot be avoided, good light is worth its weight in gold.

A reinforced suspension is an advantage for the mostly heavily loaded travel companions and also usually provides additional ground clearance. More robust shock absorbers are often included with these modifications.

Preparation

Tires

Nice fat oversized tires with a rough profile may look cool, but the disadvantages usually outweigh the advantages. Such tires can hardly be replaced in most developing countries and the greater weight puts additional strain on the wheel bearings, which are already under great load. It is better to stick to the tire dimensions, which are fitted elsewhere on the comparable vehicle types in the countries to be visited. For example, the websites of Toyota Landcruiser/Hilux and Ford Ranger provide good guidelines for common dimensions of off-road tires in the respective specifications. However, it is still not certain whether the trusted brand can also be procured, but there are certainly alternative products available.

A rough tread profile only makes sense if you deliberately travel to areas where muddy tracks cannot be avoided over long distances. If the route is optimally planned, this shouldn't be the case. Incidentally, snow chains can also provide excellent service in mud.

Otherwise, "fat" tires have mainly disadvantages: They are loud, the fuel consumption is higher, the steering and braking behaviour on tarmac is worse and the service life is usually shorter because they will mostly be used on tarmac roads and good gravel roads (metalled roads) anyway, where they wear quick and uneven. A mud terrain tire with a few millimetres of tread depth will not help in the mud either.



Figure 56 Popular with Overlander: BF Goodrich KO2 tires (underway.ch)

Most Overlander opt for good and, above all, robust all-terrain tires. The most common among world travellers are the expensive, but also well-proven [BF Goodrich AT KO2](#). Although they cost significantly more than most other brands, they also deliver what is promised. Incidentally, these tires are also approved and

Preparation

tested as winter tires.

Truck drivers have to plan doubly well, because tires of the same quality are often difficult to obtain on the road, especially for the ex-military trucks with off-road tires. The main reason for this is that in developing countries usually only military vehicles are equipped with such tires and they are therefore often difficult to find on the open market. This should be clarified in relevant specialist forums before the trip, as well as what the most common dimensions are.

The tires for vans or other non-off-road vehicles should also have all-terrain profiles, if suitable, because a robust tire with increased traction is also an advantage for such cars, because roads can surprisingly be unpaved, slippery or rocky.

Often, however, no suitable dimensions are available on the market for these vehicles or they are not permitted by law. In this case tire types that are matched to the usually excessive weight of the vehicle, plus some reserve, should be selected. In addition, care has to be taken to ensure that the carcass and sidewalls are made up of as many plies as possible. These are clearly more robust and the chance of flat or destroyed tires is minimized. LT tires (Light Truck) usually meet the requirements.

Spare Tire

Many swear that it is necessary to have two spare wheels on board. In practice, however, it is highly unlikely that a second puncture will be caught before the first has been patched. It makes more sense to take a tire repair kit with you, it takes up little space and doesn't cost much. However, knowledge and tools are then required to be able to pull a tire off the rim, otherwise only small nail holes can be repaired with "rubber worms". In any



Figure 57 Tire repair Mexican style (underway.ch)

Preparation

case, it must be ensured that the tire can be pumped up again after the repair. For this, and also to be able to adjust the tire pressure for off-road driving, a powerful compressor should not be missing on board a touring vehicle. However, the choice should not fall on a cheap product; it is worth investing a little more. Otherwise, it can be said that the less developed a country is, the more tire repair shops you will find. These repair quickly and inexpensively, even if the tools and compressors often seem archaic.

Shredded or severely damaged tires cannot be repaired. However, this usually only happens when a flat tire is noticed too late or the tire bursts due to overload, often because it is not matched to the vehicle weight. The former situation can be prevented by installing a pressure monitoring system if this is not already installed at the factory. With it, an imminent puncture is noticed early on and a total loss of the tire can usually be avoided. However, a factory-installed [pressure monitoring system](#) only partially fulfils the desired purpose. For example, if you deliberately drive with reduced pressure, this usually leads to an (annoying) alarm. Also, the pressure and, above all, the tire temperature of individual tires cannot be read as a value, which is actually a very helpful analysis option.

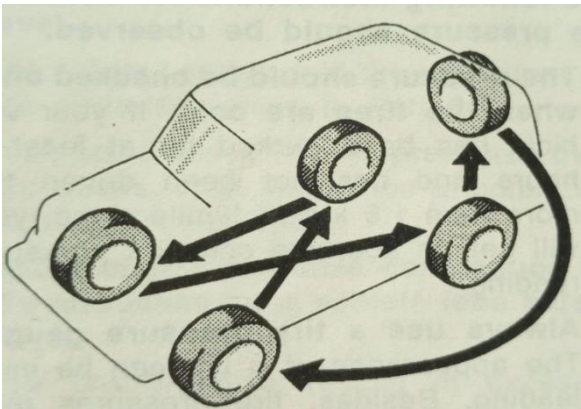

Figure 58 Regular wheel rotation. (Toyota Landcruiser manual)

By the way, the spare wheel should be regularly rotated along with the other four wheels following the same pattern. This ensures even tire wear and the spare wheel will never die of old age. In addition, the longest possible service life of the set of tires is achieved. The most

sensible interval is 10,000 km, since good off-road tires should definitely last 50,000 km. If tire pressure monitoring is installed, it must be

Preparation

noted that the sensor position changes when the wheel is rotated and must therefore be switched to the correct wheel.

Recovery Gear

A sturdy, heavy-duty recovery belt or rope should certainly be included, even if it is hopefully only used to help others. A Snatch'm Strap, an elastic recovery strap, is only recommended as an additional accessory when travelling, as it cannot be used in all situations and requires skills about how to safely use it from those involved in the recovery operation. These straps are not to be used for towing. If there are no open hooks as anchor points on the vehicle, additional shackles must be carried. Instead of the heavy and dangerous steel shackles, [soft shackles](#) have proven their worth.



Figure 59 Shovel and sand plates ([underway.ch](#))

A robust shovel should not be missing. Hopefully it will be used primarily when camping and around the campfire, but still, it should be included, and if possible one with a long handle so that it can also be used under the vehicle to free it. A very good solution is the modular [Diggar shovel](#) from Bushranger in Australia.

A saw and an axe can be useful not only when collecting campfire wood, but also when there are trees laying across the track. The only question is whether there is enough storage space for large tools. With the necessary expenditure of time, smaller models can also solve large problems, but one should not skimp on quality.

Most off-roaders carry recovery tracks of some kind with them. However, they will normally only be used if you are planning long sandy passages or even dune trips. However, they can also be used to a limited extent in muddy terrain. The traction aids from [Maxtrax](#) are popular and proven. They're expensive, but unlike cheap knockoffs, they

Preparation

sure work. The only thing they don't tolerate well is spinning wheels because they can melt from the frictional heat or the nubs are destroyed in the process. For bridging ditches and holes, as well as for use with trucks, only very robust metal tracks are useful and then usually only if they are double-layered



Figure 60 Winch recovery in soft sand (underway.ch)

because there are no anchor points. In addition, with a little patience, there is usually a chance of being able to count on outside help. If you venture into areas where a situation could arise in which a winch would be the last solution, you should consider carefully before starting the adventure, to go together with at least another vehicle.

If the decision is made to purchase a winch anyway, the necessary accessories should not be forgotten. This includes a pulley to double the pulling force, a tree protection strap to safely attach the winch cable to a tree and at least one shackle. The tree protection strap can also be replaced with a recovery strap, which can as well be helpful for extending the winch cable.

In summary, it can be said that a winch does not offer any outstanding benefits on a trip, but it does certainly add around 100 kg of additional weight (winch, bumper, accessories). Also, all the equipment will cost beyond \$2000.

Preparation

If you think of a cable pull as an alternative, you should consider that this equipment also requires a lot of space and is also quite heavy. In addition, the achievable force is rarely strong enough to pull a fully loaded travel vehicle out of a mudhole.

Tools

A good set of tools is always helpful even if you are only competent with basic mechanic's skills, because in less well-developed countries the workshops are often equipped with good mechanics, but only with basic tools. It is important to find out whether special tools are required for the selected vehicle in order to be able to do at least the most common routine work and repairs.

In an emergency, you should be able to safely and competently carry out the following work with the tools you have with you:

- Change of all fluids and filters
- Change brake pads
- Changing a wheel, possibly even changing a tire

It is also worthwhile to consult vehicle-specific forums, companies specializing in long-distance travel vehicles or even your trusted garage on this subject.

It may also be necessary to use special tools for certain routine work. An example is adjusting the wheel bearings on the Landcruiser J7, where a 55mm socket is required, a tool most garages do not have available. On the other hand, you can also use a chisel instead, not as elegant, but it works too. Otherwise, a well-assorted tool set of good quality is sufficient.

Tools are heavy, need storage space and tend to rattle in the car. A compact storage solution are tool rolls. These are space-saving and the tools wrapped in them are well protected and clearly arranged. This is an option worth considering, especially when only limited storage space is available.

Preparation

A large socket wrench set should be on board, but it takes up a lot of space in its typical case. But the sockets can also be carried in a robust bag to save space and without rattling. Clearly not so well arranged, but space-saving.



Figure 61 Tool rolls require little space (underway.ch)

It is just as important to carry repair material that can be used for general fixes, such as various adhesives, sealants, cable ties of all sizes, wire, electrical material such as plugs, clamps, fuses, stranded wires, etc. If you do not have any experience of your own, you should seek advice from people who were on similar journeys and, if possible, in the same vehicle.

It is also an advantage if a comprehensive workshop manual is at disposal. Not only to be able to lend a hand, but also to be able to offer assistance to a local mechanic, who might not be familiar with your vehicle.

Sewing Kit

Not only technical equipment or the car needs repairs. Quite often you will be faced with ripped clothing or you will have to make a stow-bag for some of the equipment. But if you have to fix heavy textile or leather a regular sewing kit is not sufficient. However, a proper sewing kit doesn't take up a lot of space and should therefore be on board.

Preparation

Spare Parts

It is certainly a good idea to carry at least one set of "service material". This includes: All filters, wear parts and any other material that is required for regular maintenance. If the used vehicle is an "exotic" model, it is all the more important to have wear-and-tear spare parts with you. It can be quite expensive and time consuming, if not impossible, to have parts shipped to you. Whether you also have to carry engine and transmission oil with you depends on how exotic the specifications are. For example, certain Land Rover models require special synthetic oils, which are difficult to buy in many countries.



Figure 62 Spare part market; Bolivia (underway.ch)

On the other hand, whatever you will need, will most likely be missing on board, and vice versa. On this topic, too, it is worthwhile clarifying at home what parts are readily available on the trip. For a 70 series Landcruiser, all common parts can be bought in Australia and Africa without any problems

and it is very likely that they are a lot cheaper than at home. On the other hand, it cannot be expected that special parts for a Bucher Duro are in stock anywhere at all.

However, too much can be carried along too. A complete alternator, for example, makes little sense, since the starter battery can be charged with the solar system in an emergency, even if it takes some time, of course. You can then get back to civilization with the battery alone, but you probably have to test whether it works that easily with a modern vehicle. The focus should be on components that, on the one hand, are notoriously unreliable and, on the other hand, in the event of a failure, progress, even with improvisation, is no longer possible. For small and inexpensive parts, such as brushes for the starter or alternator, less restrictive selection criteria can also be applied.

Preparation

You should carry a good selection of bolts, washers and nuts on board. Especially sizes that are installed on the vehicle, in particular those with a fine thread, as these are difficult to get in normal shops. A couple of threaded rods with different thread sizes allow you to make your own screws of any length with the help of nuts.

Best of all, however, is to travel in a robust, well-maintained vehicle so that under normal circumstances critical failures do not occur in the first place. In the event of major engine damage, it can never be repaired with on-board resources anyway. But even for such serious problems there is always a solution. It might cost time and a lot of money, but the journey doesn't have to end there.

A crux of the modern models with all their electrical and electronic helpers is, that outside of Europe and North America there is little knowledge about them and the usual and necessary tools are often missing. But even if an error can be diagnosed, this does not mean that the necessary spare parts can be procured locally. This applies in particular to the complex exhaust and electronic systems that are installed in almost all vehicles of today.

A list of the most important spare and wearing parts, including the original spare part numbers and, wherever possible, part numbers from alternative suppliers (OEM, after market) helps to procure replacement material underway. Even if your own vehicle model may be common in the destination country, they are often specified differently, so that not all spare parts are always the same. Since parts are often determined by means of visual comparison in less organized countries, it is customary to visit the dealer either with a new part or with the old part that has already been removed. In Western countries, on the other hand, spare parts are often only determined using the VIN (Vehicle Identification Number) on the computer. But procuring parts for a European vehicle model from a US dealership will usually not work using the VIN, because the systems often only store number groups of vehicles that were sold in the local market. This also often applies to

Preparation

service and repair work, where agencies simply refuse to work on the vehicle if the VIN cannot be found in their system.

In the end, only independent garages that still use common sense to judge and work will help in this case.

Don't forget spare parts for the rest of your equipment. Wear parts such as water filters or cleaning chemicals can be difficult to find. But even critical parts such as a drinking water pump are not easy to obtain everywhere. Here, too, it is important to carry material that can be used for general repairs, silicone, water hose, etc.

If there are no shops selling components for campers, you should look around in port cities, because there is the possibility to find a yacht chandler. Sailing yachts and large motor boats require much similar equipment as a camper.

HINT

Further information on the topic of "travelling in a 4x4", including equipment and accessories, is covered in a separate book, which is available for download here: [>LINK<](#)

Camping Equipment

Kitchen



Figure 63 Gourmet food on the trip ([underway.ch](#))

It is well known that elaborate cooking is not for everyone. However, in remote areas with little tourist development, cooking for yourself is often unavoidable. The greater the interest and basic knowledge of cooking, the better equipped the galley should be. Whether you eat from porcelain and drink wine from crystal glasses is of course up to your own taste and style.

Preparation

For longer trips, you should not skimp on the quality of the kitchen equipment, because on the way it will be difficult in many places to get adequate replacements. Space requirements can also be an important aspect. Depending on the vehicle, there might be the requirement to take up as little space as possible. It is important to choose dishes and cooking utensils in such a way that the equipment can be stowed away as compactly and rattle-proof as possible.

A pressure cooker is not only a very practical piece of equipment, but also almost indispensable at high altitudes such as in the Andes or the high mountains of Asia. The boiling temperature of water decreases with increasing altitude, it is only 85°C at 4000 m above sea level, for example. Therefore, many dishes can no longer be cooked properly, or at least it will take much longer. In addition, the pressure cooker is generally very good for cooking stews, soups and dried legumes, even the meat of a camel that has died of old age can be cooked in less than an hour. In general, the cooking times can be more than halved, which in turn saves fuel. Cooking in a pressure cooker also minimizes odours and moisture in the vehicle.



Figure 64 Kovea pressure cooker (underway.ch)

Unfortunately, most of the models sold in normal household goods stores are too big and often have a long handle, which takes up a lot of storage space. The [Kovea](#) model, which was specially developed for camping use and is highly recommended, is unfortunately not easy to find in Europe. But

if you search Google “pressure rice cooker” you will find some alternatives and sources.

If you don't want to do without baked goods, lasagne or gratins when you're travelling, you should equip yourself accordingly. If there is no

Preparation

possibility to install a gas oven in the vehicle, there are other, quite simple solutions.

Coleman has historically offered a foldable oven that sits on top of any two-burner stovetop. However, it is better to use it outside, as the waste heat is quite excessive. It works best when there is no wind or protected from the wind, but also when the outside temperature is rather warm. The reason is, the oven is not insulated and the flames from below tend to be "gone with the wind". The product seems to be no longer on sale, but can still be found from stock or used.



Figure 65 Coleman folding oven (underway.ch)



Figure 66 "Omnia" bread (underway.ch)

Alternatively, there is the [Omnia](#) baking device, which is also popular with Overlander. This can be used for almost all recipes that are usually cooked in the oven. The only "downside" is that everything is in the shape of a donut, but that's certainly acceptable. Omnia can be used on all common stove types.

If weight and space do not play a major role, the additional purchase of a camp or Dutch oven can pay off. In countries where it is easy to cook on a campfire, cooking and baking is an exciting experience. Especially in Australia and Southern Africa, but also in North America, the use of a camp oven is very common.

Preparation

It doesn't have to be a huge thing; 4-6 litres are enough for two people. It is helpful if the lid has a rim so that embers can be placed on top when baking. A raised grid made of perforated sheet placed on the bottom prevents baked



Figure 67 Baking bread in a camp oven ([underway.ch](#))

goods from burning. Working with a camp oven requires a fireproof shovel, heat-resistant gloves and a sturdy long-handled metal hook to move the pot and lid. There are even [special camp oven recipes](#) (GE), but basically the cast iron pots can be used for almost all cooked, roasted and baked dishes.

Additional information on the subject of camping kitchens can be found here: [>LINK<](#)

Chairs

There are probably no camping chairs that survive a multi-year journey unscathed. Chairs are used almost every day, often for many hours, much more often than garden chairs at home. Therefore, when choosing, it is worth paying attention to good quality and robust construction, even repairability. The cover fabric on the seams and the rivets on the hinges and joints are prone to defects. On the road, it will only be easy to find an adequate replacement in a few countries, usually only where there is an established camping and outdoor culture.

The chairs must also have good stability on soft or uneven ground. It should also be noted that the chairs can be used both for eating at the table and for comfortably hanging out around the campfire. Depending on the storage options, different designs and sizes are advantageous.

Preparation

Folding chairs (right) that can be pushed together are comfortable, stand up well and don't take up too much space. Folding chairs (middle) usually require more storage space. If you are short on storage space, you will find models that require very little space (left) but are more complex to set up.



Figure 70 Helinox Chair One Minichai: light weight, small, complicated set-up



Figure 70 Folding chair: more space required, less stable standing



Figure 70 Folding chair: well standing, small pack size, comfortable

Camping Table



Figure 71 Bush camping (underway.ch)

High demands are also placed on the camping table. It should be light, easy to store, quick to set up and take down, durable and, above all, stable. If possible, a large, possibly even a foldable table top should be chosen. The reason is that cooking is often done outside at

the table and guests should also be able to find space.

Preparation

Height-adjustable legs with large feet are very important. This is the only way to ensure that the table is stable on uneven and soft surfaces. But the storage space on board is not always available to meet all these requirements. A roll-up table top might be more suitable, but this design has other disadvantages, therefore it is important to find the best compromise.

Insect Protection

In tropical regions, but also in the far north, insects can spoil the evening outside or even threaten your own health. In order to prevent being forced to stay in the, hopefully insect-proof, vehicle all the time, appropriate precautions should be taken.

One possibility is to supplement the existing awning with a mosquito tent, this option can be retrofitted for some models.

However, this only makes sense if it is reasonably large and the storage space for the tent is available.



Figure 72 Mosquito tent as an awning accessory
(source: www.gordigear.de)

At least the table and the chairs should have enough space underneath. Such mosquito protection tents are also available free-standing, but then they require even more storage space. Otherwise, all that remains is to protect yourself with appropriate clothing and mosquito spray.

Preparation

Photo- und Video Equipment

Most travellers document their trip in some form with film or photos. Depending on your expectations, your own skills and the planned use of the recordings, you have to invest in appropriate equipment. Equipment that is to be taken on a trip should be extensively tested at home and its use must be practiced. A basic requirement for the equipment is robustness and dust and water tightness. The equipment will be exposed to vibration and the weather over a long period of time, which puts a constant strain on it. If something breaks along the way, not only will snapshots become impossible, but repair and replacement can be a challenge.

Camera Equipment

Anyone who usually documents their experiences with their cell phone or only publishes what they have experienced on social media, can certainly do without heavy, expensive equipment.

However, most people will acquire specific equipment. Until recently, high-quality full-frame cameras were inevitably expensive, heavy and bulky.

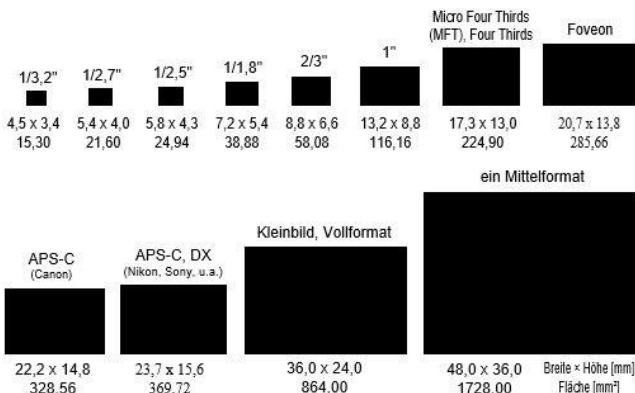

Figure 73 Sensor size comparison.

(Source: Xpiousa - Eigenes Werk, CC BY-SA 3.0, <https://commons.wikimedia.org/w/index.php?curid=5329654>)

But since many of the well-known manufacturers have also brought mirrorless full-frame models onto the market, this is no longer the case. However, high-resolution professional cameras only make sense if you intend to use the

pictures taken to create large-format prints or public presentations.

Preparation

If you intend to only view the images on screens, a good camera with APS-C/DX format is completely sufficient. If you want to post-process the images on the computer, the camera should definitely allow taking images in RAW format.

Depending on the photographic interests, more than a single lens is required. Wildlife and macro photography in particular require lenses with specific properties. There are relatively good superzoom lenses available, especially for cameras with APS-C sensors. This means that the entire focal length range from wide angle to medium telephoto can be covered with just one compact lens (e.g. 18-300 mm). Unfortunately, such practical lenses are not available for large-format cameras for technical reasons.

High-quality, mirrorless cameras are also ideal for video recordings. Meanwhile, 4K resolution is almost standard and since there are lenses available for every application, even professional recordings can be made without outrageously expensive and heavy video equipment. An external microphone is not expensive, but it improves the sound quality considerably, especially in windy conditions.



Figure 74 Nikon Z7 full frame camera (underway.ch)

Accessories

A stable tripod is particularly useful as an accessory for the ambitious photographer. There are also mini tripods for light cameras, which already offer a sufficient fixation. A tripod with a video head makes sense for video recordings, so that smooth and jerk-free camera pans can be filmed.

A flash unit is usually not necessary, good cameras combined with a tripod produce good and more natural-looking images even in poor light. Don't expect too much from the flash units built into cameras.

Preparation

The illumination power is usually limited to just a few metres. That's enough to light people around a table or a portrait, but for entire rooms or more you would need a powerful or even multiple flash units. Integrated flashes are also hardly useful for macro shots.

If not built into the camera anyway, an external remote release can expand the range of uses. Many cameras can also be controlled via a mobile phone app. If time-lapse recordings and long exposures are planned, additional accessories may be required.

If a camera with interchangeable lenses is in use, a cleaning set should be included in the luggage. Even if you work carefully, sooner or later dust will settle on the sensor and spoil the images with ugly dots. This can easily be corrected with a suitable sensor cleaner.

Image composition with filters has lost some of its importance in digital photography, because many things can be "patched up" later on the computer. However, a polarization filter can excellently eliminate unwanted reflections during the recording. This helps above all when you have to take photos through glass windows and water surfaces. A colourless skylight filter protects the exposed front part of the lenses, but can also lead to unwanted reflections and quality impairments.

Drones

The use of drones has increased massively in recent years. Which model is best depends once again on the budget and the desired specifications. Before deciding whether a drone should be taken on the trip, the legal situation must be assessed. In many countries, it is forbidden to import drones, sometimes with severe penalties. In most countries, the deployment is also subject to rules, permits and restrictions. In Iran, for example, an Australian couple was jailed for months for allegedly spying with the drone in the middle of nowhere. Morocco, as another example, is very strict on import bans, the fines are heavy and the drone is confiscated if you get caught.

In tourist hotspots and national parks in the western world, the use of drones is now banned almost everywhere

Preparation



Figure 75 Drone picture of a camp (underway.ch)

Actually, flying in remote regions would not be critical, not least because there is hardly any surveillance and nobody would feel bothered, but the device first has to be "smuggled" across the border. Since every illegal border crossing entails a corresponding risk, it is quite possible

that something will go wrong. Therefore, it should be considered very carefully whether it is worth taking a drone with you. Here is an overview of the [existing rules](#).

If you still decide to procure a drone, it makes sense to think about the requirements. Criteria are: size, camera quality, usability, and battery life and safety features of the device.

Especially without much flying experience, simple operation and functions such as automatic obstacle avoidance and automatic return to the starting point in the event of a loss of orientation, are important. Only a built-in gimbal makes it possible to take steady shots. Batteries only offer a short flight time even with high-quality drones. Therefore, several batteries and corresponding charging options are usually required. Spare propellers should not be forgotten, because these can be damaged during a rough landing.

In any case, flying the drone should be mastered before the start of the trip, because if it crashes on the trip, it is often not possible to find replacement or repair it on site

Action Cam

These are also very popular, be it for recordings under water or in motion, spectacular videos of amazingly good quality can be made without much effort. The small, robust devices can be taken anywhere.

Preparation

However, they are less suitable for general photos, because the wide-angle optics lead to strong perspective distortion and thus recurring image impressions. Even for landscape shots, the results are unsatisfactory in terms of image composition, even if the resolution would be quite acceptable.

For time-lapse recordings in open terrain, for example to document weather phenomena, action cams are very easy to use, since the end result can be used directly from the camera. However, a tripod or at least a stable fixation is required for this. A power bank might be required to extend the operation time of the actioncam.

If used to catch the action, exciting video documentation can be created. It should be noted, however, that the raw material should be cut and accompanied by music, possibly even with a commentary. Lengthy driving sequences with wind noise as the only acoustic "enhancement" will hardly meet with great interest.

A screenplay, even if it's formed in your head only, helps to plan the individual scenes and settings in a sensible way. Unless a semi-professional documentary is planned, the productions should be limited to short clips. 5 minutes is quite a long time, unless the topic and the style are extremely exciting. Sequences of 30 seconds to about 3 minutes are more common. A single scene is more exciting if the viewer has enough time to absorb the picture, 5-10 seconds is usually optimal, sequences that are too long are boring, and sequences that are too short are annoying. Overly creative and hectic scene transitions are also not conducive to quality. On the other hand, a calm and fluid camera motion increases the quality of moving scenes considerably.

Even if the GoPro cameras still dominate the market, there are a number of cheaper alternatives. This type of camera always requires attachment accessories for optimal use in motion. Be it a helmet mount or a secure attachment to the vehicle, there are countless variants to buy. Since these accessories are usually model-specific, this can also influence the decision which the camera to buy.

Preparation

Additional information on the subject of "filming and photography" can be found here. [>LINK<](#)

Computer Equipment

Most of today's Overlander will probably carry more or less extensive computer equipment with them to document the journey, to plan it or even to work. The computer is as well the tool required to take care of banking matters and contact with the authorities.

Laptop Computer

The most important properties of a computer that you carry with you are: robustness, low weight and compact dimensions, but a high-quality screen and long battery life are also required. If the laptop is also used for cutting videos and for photo editing work, a powerful processor and a fast graphics card should not be missing. Since you might like to work outside, a bright and non-reflecting display is of great importance.

An SSD hard drive is significantly more robust and therefore more resistant to the unavoidable shocks and vibrations. It is also energy-saving and faster. A well-padded and dustproof bag is useful to protect the device.

All these requirements can actually only be covered with a high-quality and therefore rather expensive device. Inexpensive consumer models also tend to give up the ghost on a long trip. Replacements will be difficult to find, and if so, only with local software and keyboards, and often with basic specifications. In addition, in the event of a failure, there is the loss of data and the effort required to reinstall the software.

The required activation codes or data carriers with the original software for the most important tools should be taken with you on the journey in case the computer breaks down or is stolen. If not, the programs must also be purchased locally. It is also worth creating a comprehensive program and data backup beforehand.

If there is no 230 V supply on board, a 12 V power supply allows to charge the device from the cigarette lighter plug while driving. How-

Preparation

ever, be careful when buying, some laptop manufacturers exclude third-party chargers or restrict their use. So be sure to test it before you leave.

HINT

Due to the use in a dusty environment, the laptop will sooner or later become very dirty inside. Signs are when the fan runs frequently and the computer still gets unusually warm. The only thing that helps is opening the device housing and blowing it out carefully.

Tablet Computer

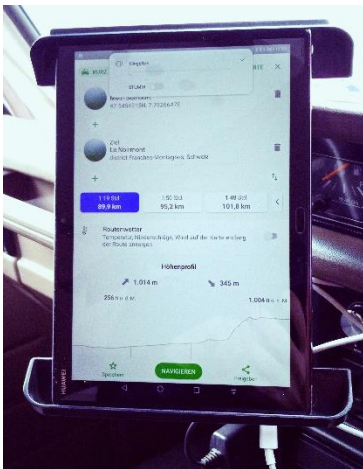

Figure 76 Tablet used for navigation
(underway.ch)

In addition to a laptop computer, a good tablet makes sense. Such a device can be used as an e-book reader, for surfing and for navigating. A display that is easy to read, even in daylight, is important for this. Charging via USB is efficient and easy to do.

If it is used for navigation, a robust vehicle mount and a USB connection for power supply nearby should be provided.

External Hard-Disk

In order to additionally save data and images, one or more generously dimensioned external hard drives should be planned in. Preferably these are also SSD types. They are more robust and also smaller than a conventional hard disk.

Printer

If you have enough space on board, a portable printer, preferably one with battery operation, can be a useful addition, be it to copy forms or other documents on the way or to print photos as a souvenir for a host.

Preparation

But on the other hand, there are now small businesses almost everywhere in the world that offer document printing from a USB stick as a service for little money.

Mobile Phone and Internet

Nowadays it is almost unthinkable to travel without a cell phone and Internet. Meanwhile, most countries are also quite capable of meeting the needs in this regard. GSM networks in particular are usually quite well developed and often even offer better coverage in rural areas than at home. But highly developed countries such as the USA and Canada are not good examples, as they do not offer good coverage away from the main axes and agglomerations, telecom companies simply look at where it is profitable and where it is not. Third world countries, on the other hand, can cover large areas of land quite cheaply with a few strong transmitters.

The situation is different with Wi-Fi availability. Whereas in Western countries there are usually many and fast access points, this is usually scarce in less developed countries, simply because the infrastructure is not provided. In general, the bandwidths of campsite Wi-Fi, for example, are rather limited and if a lot of people are streaming Netflix, it's over anyway.

Which Cell Phone is Suitable?

There are actually only two main aspects to consider:

1. The mobile phone should have space for a second SIM card. Of course it is possible without, but that means that if you want to keep the SIM card from home when you are away, you can only use either or.
1. It should be able to use multiple frequency bands.

There are several different frequencies for GSM networks worldwide. In order to be able to use a device in every country, you should buy a [tri-band](#) model.

Most modern devices meet both requirements. Alternatively, you can of course also have a second device with you, so why not recycle one of

Preparation

the old mobile phones. If you don't get a mobile router (see "International SIM cards", below), it's advantageous if the mobile phone is hotspot-capable, but again that's actually standard these days.

Local SIM Cards

Since it is usually cheapest to get a SIM card locally, this is the normal case for travellers. However, there are also countries where the administrative effort involved in buying a SIM card and putting it into operation can be quite large.

More on this topic here: [>LINK<](#)

International SIM Cards

Roaming charges are still incredibly high in many countries. A laudable exception is the EU, because with an EU SIM card you can surf and make calls at least in all member countries without extra charge.

A possible alternative are international SIM cards. These allow use in countless countries worldwide. Often, however, some offer only data packages, so that telephony can only be made via the relevant VoIP providers such as Skype, Messenger, WhatsApp, etc.

You can insert these SIM cards into your own mobile phone or install them in a router and thus operate a hotspot for all devices on board. The only disadvantage is that the data packages of these SIM cards are quite expensive compared to local cards, but they are still significantly cheaper than roaming.

For example, [Keepgo](#), one of the many providers, costs about \$60 for 3 GB. These are valid for 12 months and the validity is restarted with each recharge.

But in addition to this provider, there are countless other options, in today's fast-paced world you have to research if necessary. International SIM cards can be a reasonable option if you intend to stay only a few days in each country and/or changing for and back several times.

Preparation

Satellite Phone

In very remote regions, a satellite phone can be a crucial tool to organize help in an emergency. This type of communication will hardly be used for evening chats, because a minute still costs several dollars. But even if the telephone is only used as an emergency device, the costs are considerable. The problem is that the pre-paid credit usually expires after a short time and therefore has to be bought again and again even if it is not used.

Whether it makes sense to buy a satellite phone depends primarily on your own need for security and whether the benefit justifies the investment. If it's just for emergency use, you might want to consider a satellite tracker with 2-way communication (see next chapter). If you're toying with the idea of using a satellite phone for internet access, that's hardly going to be a viable option, too slow or/and way too expensive.

Before deciding to procure such a device, it must be clarified which regions are to be covered at all. Three main providers offer their services, but not all can be used globally:

Iridium

With its satellites, Iridium covers the entire planet. The devices and especially the telephony and data are quite expensive. The smallest pre-paid top-up is 75 minutes with a term of 30 days (price: \$ 170) Even a validity extension of 1 month costs an additional \$ 60! Telephones are all priced above \$ 1200.

Thuraya

With **Thuraya**, Europe, Africa, Asia and Australia are well covered with just two satellites, but America and the Pacific are not. It has several phone models on offer, some also combined with GSM, i.e. you use GSM as long as there is reception, and otherwise the device switches to the satellite network



Figure 77 Sat phones are hardly any bigger than

Preparation

The devices and the telephony are quite reasonably prized. Pre-Paid credits from \$ 45 (must be activated within 12 months). Telephones from about \$ 600.

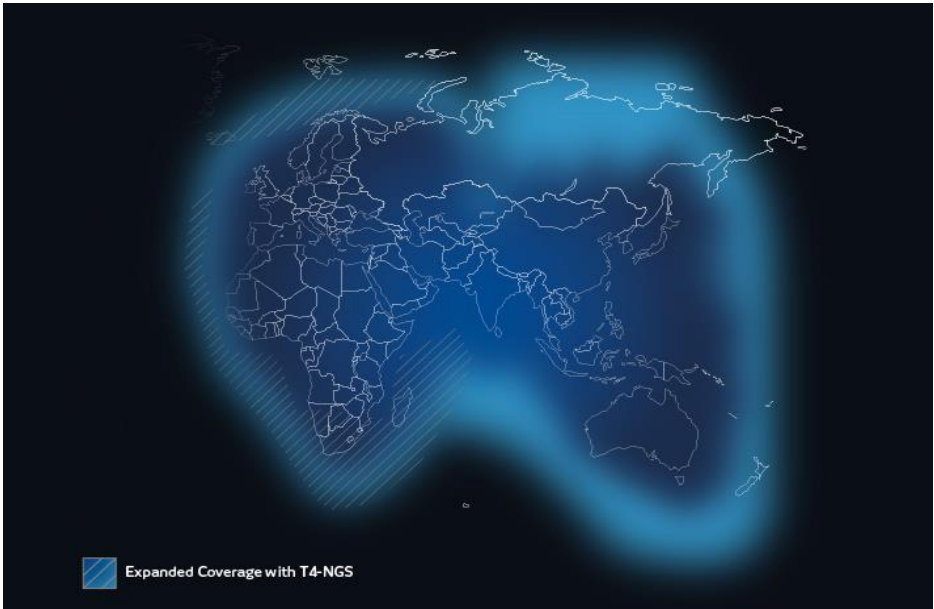

Figure 78 Coverage of the Thuraya network (source: www.thuraya.com)

[Immarsat](#)

The company aims more at commercial users and solutions, but also has mobile devices in its range. The network coverage is global. Prices for mobile devices start at around \$ 700, pre-paid from around \$ 60 for 30 minutes, valid for 30 days

Satellite phones can generally only be used with a clear view of the sky. A separate external antenna is required for permanent use in the vehicle, but it only works in open terrain.

With all providers, the data can only be used for text e-mails and SMS. Surfing and streaming are technically possible to some extent, but hardly affordable for a traveller.

Preparation

Satellite Tracker

This type of device has the following basic functions:

- The position is permanently transmitted to a server and the itinerary can be displayed on a personal website on the Internet
- The devices make it possible to send an emergency call directly to a global emergency call centre via a satellite connection. They will then organize the best possible local rescue chain.
- Depending on the model, 2-way communication via SMS is also possible.

There are two well-known suppliers on the market. Both have comparable functions, Garmin is a bit more expensive, but some of their high-quality models can also be used as GPS receivers.

WARNING

If you intend using the tracking function to display your journey and actual position on your website, you should be aware, that this information can be seen by anybody with access to it.

To prevent unwanted visitors to your bushcamp, it is advisable to hide this part of the website behind a password, which is only given to trustful people. This measure is particularly important if your website address is visible on your vehicle. See also [>LINK<](#)

Garmin

The Garmin inReach functionality is built into several Garmin GPS device models. Device prices start at around \$ 450, the monthly basic fees from \$ 18, including permanent tracking it's min. \$ 45. Garmin inReach has global satellite coverage. The SOS messages to the Garmin alarm centre are included in the subscription price.



Figure 79 Garmin inReach mini (source: www.garmin.com)

Preparation

Spot



Figure 80 Spot-X (source: www.findmespot.com)

The device prices are slightly cheaper at \$ 180-350, but have no GPS navigation functionality. The monthly basic fees start at \$ 18. Flexible subscriptions for short periods are slightly more expensive.

The emergency call coverage includes almost the entire land masses of the earth, but not the Pacific Ocean. There is also a coverage gap in Central Asia for 2-way communication. Access to the international operations centre must be ordered separately (\$ 30 /year)

A comprehensive overview of the three satellite phone systems and Garmin satellite trackers can be found here: [>LINK> \(GE\)](#)

ATTENTION:

There are also GSM based trackers. They are very cheap, sometime it's just an app, but they only work as long as there is GSM (mobile phone network) coverage. They are therefore NOT suitable for emergencies in remote areas. A route covered outside of the cell phone network cannot be completely documented either.

Wi-Fi on the Road

Meanwhile, public Wi-Fi is common in most countries. You can find them in public facilities, in South America even in city parks, or in businesses such as shops or restaurants. Sometimes it helps to drive through a city at a slow pace to discover an open access WLAN.

In the popular iOverlander app, you can also find Wi-Fi spots in some areas, but most are just mentioned in the accommodation options.

Preparation

If you use a public Wi-Fi, especially on campsites, the range or signal strength is often insufficient. As a result, the already weak Internet connection often becomes useless.

One solution to improve the situation is to use a booster antenna.

How does it all work?

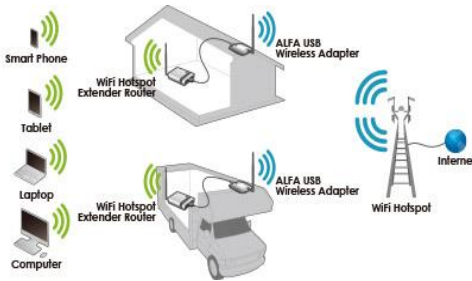

Figure 81 Wi-Fi amplifier

(source: [www. https://www.alfa.com.tw/](https://www.alfa.com.tw/))

The antenna picks up the weak signal and transfers the data to a Wi-Fi router via a USB cable. This in turn radiates the amplified signal to the environment and forms a private Wi-Fi. Anyone who has the password can then connect.

What do you need for that?

Basically you need the following components:

- 1 antenna with amplifier
- 1 router to distribute the signal in a Wi-Fi
- 1 USB connection cable to connect the two components

A simple and popular package solution is the [ALFA Wi-Fi Camp Pro](#)

There is a similar system from the same manufacturer, but it is based on the 4G mobile network, i.e. even a weak 4G signal is received and forwarded to the receiving devices via private Wi-Fi.

These packages are optimized for mobile use, such as in a camper or on boats, and contain all the necessary components. Installation and commissioning is quite simple. The system can be permanently installed or be ready for mobile use in a short time.

Preparation

Internet via Satellite

As previously mentioned, transferring data over a satellite phone is not only very expensive, but also very slow. Therefore, this option is hardly suitable for an "around the world trip".

Since a while available is the "[Starlink](#)" network. From about \$100 per month you can get unlimited data with very good bandwidth. The coverage is worldwide yet not all countries and regions have the same accessibility.

There are even hardware sets and plans available for mobile applications. The best and most versatile but also the most expensive solution is a flat antenna to be mounted on the roof. This allows communication in motion. A transportable antenna on a tripod is much less expensive but limited to be used in the camp. There is a big price difference whether you want to use the device in a single country or region or globally.

The power consumption of standard equipment is quite remarkable, thus not really suitable for permanent off-grid operation. Some users have modified the gear to be more energy efficient and 12 V. Check Youtube based instructions for more details. Search: "Starlink 12V offgrid"

Software Tools

Various software tools also help to efficiently carry out the tasks that arise when travelling. Some of these are mentioned below. These are apps for mobile phones or tablets as well as PC programs.

Although mainly Windows or Android compatible products are described here, comparable solutions are also commercially available for Apple operating systems and many are even available for both worlds.

Useful Apps

There are functionally similar alternatives for many of the apps presented below. It's worth trying out and getting to know a selection before you commit and start.

Preparation

Google Translate – The Translator

Nobody can master all languages. With the [Google Translate app](#), also with the desktop version, it is often possible to get by without any knowledge of a foreign language. The online language translation works quite well, depending on the language, and even with the camera-controlled real-time translation, simple texts such as labels, street signs and menus can be translated. However, one should not have too high expectations. Complex sentences or certain languages still overwhelm the tool, but the meaning of the text can usually be understood.

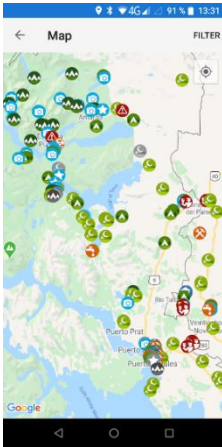

iOverlander – For finding places to stay and more

[iOverlander](#) is available both as an app and as a website. Although limited, the app can also be used offline. The tool forms a good basis for the worldwide search for overnight accommodation, mechanics, drinking water, shopping facilities, gas bottle filling stations, etc. It also contains information on border crossings and road-checkpoints, as well as warnings of dangers. The tool is filled by travellers, and they can, and should, also give feedback; this is the only way to guarantee quality and up-to-date

information.



Park4night – Overnight places, mainly in Europe

App and website available. Similar to iOverlander, but primarily geared towards overnight stays with a focus on Europe, although there are a few worldwide entries. Only fully usable online for free. The focus is on motorhome owners, and the entries only partially meet the expectations and requirements of Overlander. However, since travel in Europe often restricts classic wild camping by law, travellers are dependent on official pitches and campsites. With the [Pro Version](#) subscription it also comes with of-

line maps.

Preparation



Mapy.cz – For navigating on foot and in the car

The Mapy navigation app has made excellent progress in recent times. The app is available for Android and Apple as an app and also as a [website](#).

The map base for this app is Open Street Map. The map image is very clear, and the integrated hiking map even comes with contour lines. The maps can be downloaded by country and are then available offline. In online mode, you can also switch to the satellite view.

Navigation with intermediate destinations is possible for vehicles and pedestrians and also offers several variants and options to choose from. The generated elevation profile of the planned route is also a useful feature. Depending on the region, traffic information is optionally displayed. With the app, you can also record your own journey and save your own waypoints. In addition, existing GPX data can easily be imported.

If you register at mapy.cz, personally generated GPS data will be stored in a cloud and made available on all your linked devices. You can plan a route on your PC and then use it on your cell phone. The app is free and still has no annoying ads.



Google Maps – For local location information and for navigating

This app is used by most people to find information about, or around, the location online. The app can also be used offline to a limited extent. To do this, however, regional maps must first be downloaded for offline use. Many users also use [Google Maps](#) for navigation. The map material and the navigation function are only really useful for vehicle use.

The tool can also be used very well in the desktop version to document the journey with self-designed

Preparation

maps with waypoints and self-generated GPS tracks on your own website.

For more information have look here: [>LINK<](#)



Weather Pro – For local weather forecasts

A weather app is often helpful and they are offered in large numbers. However, none with worldwide cover is very reliable and accurate. The websites of the local meteorological institutes are more suitable for this.

[WeatherPro](#) is available for Android and Apple. It is easy to use and gives a clear forecast for the location or preselected cities.



Easy Currency – Converts all currencies

For price comparisons on the go, current exchange rates are always helpful. Especially when exchanging money at the border, you can check whether the exchange rate offered is acceptable.

There are many app solutions available for this task. [Easy Currency](#) can also be used offline, but you should update the rates online regularly so that entries in the local currency can also be correctly converted into the home currency.

Since you can also look back on a multi-year history of the rates, it is also possible to manually convert old price information to current rates in any currency.

My Car – For keeping a vehicle log book

With the ["My Car" app](#), you can document and keep an eye on the fuel consumption and the maintenance/repair costs of the touring vehicle.

Preparation

In this way, maintenance work can also be optimally planned and monitored.

The fee-based Pro version is required for working with several currencies, otherwise the costs for the entry must first be converted manually into the home currency. The data can be automatically saved in its own cloud and also exported in .csv format and then statistically post-processed.

AndroMoney - For accounting on the go

In order to keep the travel expenses under control, it is helpful to use an "accounting app". This way, daily expenses can be recorded with little effort and it is always possible to see where all the money is going. It thus (hopefully) allows countermeasures to be taken at an early stage if the costs get out of hand.

The [Andro Money app](#) allows easy accounting in different currencies. You can define your own categories and thus achieve a sensible allocation of the budget. To keep the exchange rates up to date, the app just needs to go online from time to time.

The data can also be easily exported and further processed in EXCEL. There are a variety of alternatives and similar programs.

Dropbox - Data storage in the cloud

This, or any cloud app, should definitely be set up, not least to store digital copies of all important documents.

If the free storage size of [Dropbox](#) is not sufficient, you may have to purchase a subscription for more storage space.

Meanwhile, there are also many alternatives, some with large free storage. It certainly makes sense to stick to a product that is known to be reputable, since data security and privacy are important when it comes to this kind of data. Saving all the pictures in a cloud on a long trip is illusory, not because of a lack of storage space, but simply because there is hardly any Wi-Fi with enough transmission capacity to upload the gigabytes of data.

Preparation

ReadEra - The mobile library



Figure 82 E-Book Reader app on a tablet ([underway.ch](http://www.underway.ch))

[ReadEra](#) or any other e-book reader app should not be missing on board with bookworms. Of course, a suitable library must also be procured. But e-books save a lot of weight and space, which should outweigh the downside of not being able to hold a physical book in your hands. Travel guides purchased as e-books can be clearly managed in a separate list and accessed on the go.

Compared to commercially available e-book readers, a tablet with the appropriate app has the advantage of being much more flexible to use. You can also easily integrate other people's book files in almost any format into your own library, something that is usually difficult, if not impossible, to do with proprietary devices. Readable files stored on the device are automatically added to the library, including manuals in .pdf format. If these are now brought together in a separate folder, you have quick access to them if needed.

Additional App's

Other apps that may be worthwhile are those for controlling the cameras and drones that are carried along. Which ones are available and useful depends on the devices used.

PC Software

In addition to the usual Office and mail programs, other applications can be helpful underway. Some of them are also mentioned in this book in the corresponding topics.

Preparation

Adobe Lightroom

[Lightroom](#) is a powerful tool to edit and manage digital images. Unfortunately, like increasingly more commercial programs, you can only get the software as a subscription.

Images can be edited in many ways after import, which is essential, especially if you are shooting in RAW format. Since this is complex software, it makes sense to familiarize yourself with it before you travel. Likewise, in view of the thousands of images to be expected, a sensible filing structure should be used right from the start. Also standardized import procedures should be set up.

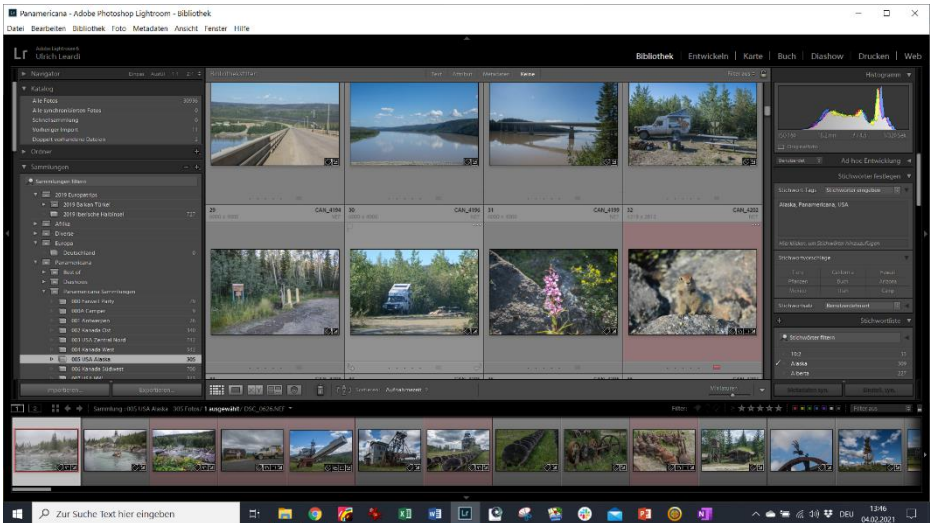

Figure 84 Lightroom for processing and organizing images (underway.ch)

However, when starting with image processing, it is also worth considering getting one of the many free programs. A look on the internet helps with the selection, some of the programs are nearly as powerful as Lightroom. In part, however, the processing and management of the images is not possible in one piece of software alone.

In particular, the open-source program [GIMP](#) is enjoying an increasing number of users and is said to offer a similar range of functions as

Preparation

commercially available software, although image management is not integrated.

If videos are also to be edited on the go, a suitable software tool must also be procured, because Lightroom does not offer a comprehensive solution for video editing.

Building a Website

Many travellers operate their own website while travelling to keep their friends and relatives up to date or even to generate an income from it. With which software and which host service, depends above all on the existing knowledge, requirements, experience and budget.

For simple, and maybe only temporary websites, a free offer can also serve. However, if the plan is to design something larger, more sustainable or more complex, it is usually unavoidable to choose a paid solution that guarantees more data security, storage space and support.

Even if you choose a free or cheap solution, you should check whether, and at what price, you can buy more storage space. It may well be that the website reaches a point where the storage space allocated is no longer sufficient and therefore needs to be expanded. You may then be forced to buy an offer that is actually intended for professional use and is relatively expensive.

Domain

Before creating a website, you have to think about a name for the domain. If you look around various travel blogs and websites, you might notice that names are often chosen that are difficult to memorize for an international audience. Names that contain hyphens and umlauts are also tricky, since it will hardly be possible to convey the information correctly and unambiguously if it is passed on verbally. So, if you are interested spreading your own website, you should look for a simple name that anyone can ideally remember in any common language and that can also be conveyed clearly verbally. Even with the ending ([top-level domain](#)), you should choose one that is widely known, despite the very creative options available. The most common and usually the

Preparation

cheapest are the country domains. The domain is "rented" for an annual fee, so it can be worthwhile to pay attention to this when choosing, because the fees vary. Another thing to keep in mind is that the domain name will usually be a decision for a very long time, although you can of course move a website to a new domain name at any time. In doing so, however, you may lose the level of awareness that you have created with great effort.

Further to note is that if the domain name is too specific, you have less flexibility to expand the topics. For example, you start the website to document a certain trip and therefore choose a name related to it. Let's assume you are planning a road trip through the USA and choose "roadtrip-usa.xxx" as the domain. Later you would also like to document a trip to Africa, what now. Also, if personal names are contained in the domain, they may they change in the future (marriage, separation, etc.). For this reason alone, it is worth anticipating future changes and content expansions when choosing the domain name.

HINT

If you observe the points below, the worst mistakes can be avoided:

- *Do not use special characters*
- *Use simple names that are as short as possible, but make a statement about the topic of the website*
- *Names that can be pronounced and remembered in as many languages as possible are advantageous*
- *Choosing a top-level domain (e.g. .ch, .de, .com) that is related to the topic makes sense*
- *Many popular and logical domains are already occupied, with another top-level domain (TLD) you might be able to avoid it. E.g. xxxx.com is used, but xxxx.ch may still be free*
- *If you can spell the domain understandably for someone with a different languages, that's a good choice...*

Preparation

Editing Software

It is a great advantage to use software for website creation that allows offline processing of the data and only requires an Internet connection when the site is to be renewed or supplemented. Unfortunately, these solutions are usually quite expensive and also rather demanding to use, i.e. less suitable for "amateurs".

Another point is that many offers are based on proprietary software. This makes it easy to set up the website, but it also means that the provider cannot be changed later without great effort. If an extensive, existing website is migrated to another system, the entire content has to be transferred to the new format bit by bit, image by image and text by text, which is a huge effort.

Structured Approach to Creating

A recommended procedure when creating content is to save all texts and images, but also all other elements used, in a directory that has the same structure as the website itself. This has the advantage that everything can be prepared efficiently and well-structured off-line, and if a good Internet connection is available, the media can be transferred to the website using "copy and paste" with little effort. Even in the event of a super crash or if the web provider should or must be changed, the effort remains manageable.

For larger projects, you should also make sure that a backup is set up, be it for the entire website or at least the raw data. By far not all website providers offer a backup, which, for example, in the event of accidental deletion, allows the previous version to be uploaded again.

The structure of the website should be planned before the trip at home, and it simplifies work enormously if similar individual pages that are repeating have been created as templates in advance. This also ensures that the appearance of similar pages remains the same and that content elements are not forgotten. Once underway, these only have to be copied online, renamed, linked and filled with content, which not only speeds up the work but also guarantees better quality.

Preparation

It is well worth the effort to plan and design the structure of the future website. Check the websites of other travellers to learn what options suit your own ideas. Don't hesitate to contact the owner if you have questions.

Social Media

If you want to be present on social media, the question is what motivates you to do so. You can use the broader presence on Facebook, Instagram and Co to access more extensive, more sustainable posts on your own website. Or you save yourself the effort for a website completely and rely on social media.

Either way, you have to consider whether you want to appear with a personal account or, whether you want to create a project-related page or account.

The author, as an example, uses his Facebook page primarily to refer to new posts on the website of the same name or to publish short-lived messages with less lasting content about them.

Whichever way you go, a plan of what you want to achieve certainly helps to make the best possible decision. Do you want to keep a defined interest group (friends, family, etc.) informed? Is the goal to build as many followers as possible on Instagram in order to earn money? Do you intend to collect "Likes" with upbeat Facebook entries? You should also consider that if you want to dance at all weddings, the effort involved in publishing and maintaining is correspondingly large. Furthermore if you're really successful, you almost HAVE to stick with it, thus requiring even more effort. Whether that is still beneficial to the travel experience you must then decide for yourself.

Insurances

Travel and Health Insurance

Depending on your personal situation and home country, your existing health insurance may or may not continue. If the existing insurance is no longer maintained, or if the cover is insufficient on a long-term trip, travel health insurance should be taken out. It is the better option to

Preparation

arrange the insurance before the journey even though there are insurance policies that can be taken out on the way. Most travel insurance allow renewing as you are travelling.

There is simple health/accident insurance, however some companies offer additional liability, theft, emergency home leave and much more within the same contract.

It should also be noted that some providers impose restrictions. For example, travellers above a certain age might be excluded, some activities and countries are excluded or the maximum insurance period and its extension is limited. It is definitely worth doing your research and reading the fine print.

Most travel health insurance policies include repatriation in case of an emergency. But in severe cases, assuming the patient is able to be transported, travel health insurance may prefer repatriation of the patient to treatment locally, because the insurance company usually does not cover in the home country, therefore avoid paying the treatment cost.

This in turn means that without being able to take out insurance again in the home country in this case, the traveller will be left with the costs. Some travel health insurances also cover short home holidays of a few weeks. This can be a great benefit for people planning regular "holidays" in the home country.

Many insurance companies exclude "risky activities" from coverage or offer it for an additional fee. It is therefore essential to read the "fine print" carefully before signing the contract, because many of the activities that are common on a world trip may already be classified as "risk", depending on the insurance company.

Instead of taking out health insurance only, the separate protection of other risks should be examined.

Preparation

Liability Insurance

Liability insurance covers damage caused to a third party. As a rule, this risk is not very great, but it can quickly become very expensive, especially in countries such as the USA. The premium is moderate.

ATTENTION

Liability, which covers driving motor vehicles, is always excluded. This risk is to be insured with a separate vehicle liability insurance.

Travel Insurance

Classic travel insurance covers loss caused by theft, loss of luggage and documents, costs due to non-attendance or cancellation of the trip and other risks.

If not already covered by existing insurance, additional cover for repatriation and search costs may be considered.

One insurance policy that covers pretty much all of the above risks and limitations mentioned above is [World Nomads](#). There, apart from the vehicle, almost everything can be insured in one package and at an acceptable price. The insurance can also be extended online at any time while on a trip. But there are also [alternatives](#) that offer similar services. If countries that are known to be expensive, such as the USA, are excluded, the premiums are usually significantly cheaper.

In principle, it makes sense to weigh up the probability and consequence of an event. An upset stomach that requires a doctor's visit will usually not cost you much without insurance, but what about breaking a leg in the USA? A few thousand if not ten thousand dollars can quickly become due. And what if you get seriously ill on the way, but the local care is non-existent or questionable? Uncovered health and liability costs in particular can ruin travel plans.

Preparation

Vehicle Insurance

With regard to vehicle insurance, as soon as you leave the covered home region, the insurance will no longer provide any cover. The European insurances, for example, only cover all countries that are also marked on the “green card”. If the vehicle is shipped to America, locally valid insurance must be taken out there. In many countries, one way



Figure 85 Providing assistance in an event of a traffic accident (underway.ch)

or another, compulsory insurance must be taken out at the border. These are usually not expensive, but the cover are rather basic. Whether the insurance can be taken out at the border or whether it has to be obtained in advance must be clarified thoroughly on a case-by-case basis. There are also some insurance companies that

cover several countries with one policy, for example in South America or the USA with Canada. Cross-border insurance coverage of this kind is also possible in parts of Africa.

A lack of liability insurance is also a popular source of income at police checks in countries where corruption among police officers is widespread.

Liability Insurance

Travelling without liability insurance cannot only have financial impacts in the event of an accident, but also legal consequences. In general, in many cases the foreigner is fundamentally the culprit and is often even put in prison as a preventative measure until the question of guilt and compensation for damages has been clarified.

Incidentally, there are also a few countries in which basic liability insurance is provided by the state, such as South Africa and Ecuador. Insurance coverage is there also automatically guaranteed, also for tourists. However, this coverage is usually very basic and often only

Preparation

limited to personal injury (or the health costs of it). Of course, this means that without supplementary insurance coverage, which in turn is difficult to obtain, large liability costs can be left on you.

Due to the constantly changing rules, it is essential to find out in advance how and where you can or must insure yourself.

An overview of existing cross-border insurance zones and information on them can be found on the interactive map on the website [Overland-ing Association](https://overlandingassociation.org)

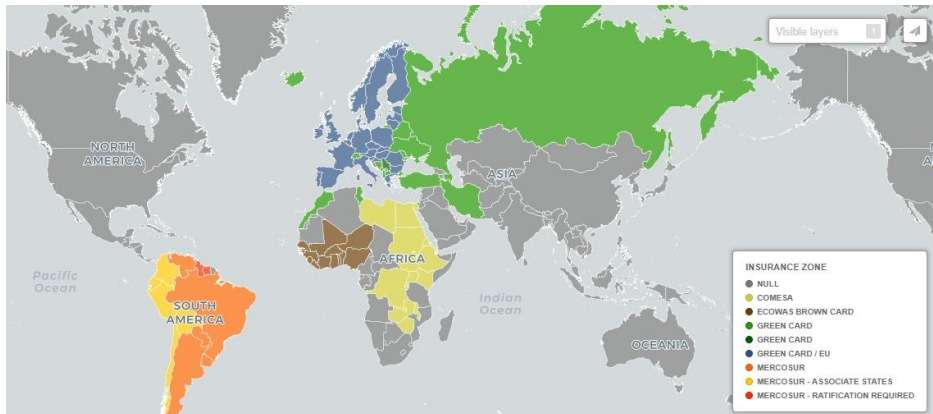

Figure 86 Wordmap of vehicle insurance zones
(source: <https://overlandingassociation.org/insurance/>)

Fully and Partially Comprehensive Insurance

Globally valid standard fully comprehensive insurance or even just theft insurance for world travel vehicles are not easy to find, if they are available at all. However, it is a topic that is discussed again and again among travellers, because many of them are travelling with very valuable vehicles. Some travellers have successfully purchased global comprehensive coverage via [CEAT](#) in Germany. Be aware that liability or border insurance is not included and needs to be organized for each country/region on top.

The risk of being left with a loss without being your fault, can be exacerbated even further if the opposing party who caused the accident does not have sufficient liability cover itself.

Preparation

ATTENTION

The border insurances are always liability insurances only, and cover often just the healing costs of accident victims are covered, i.e. property damage caused may have to be covered by the person who is guilty of the accident.

North American insurance has been difficult to find for foreign registered vehicles since 2016. Even in 2024 there are still few and only expensive options available. Some options, also for South America, are currently listed on [Panamericana Info](#) (GE).

Preventive Healthcare

Vaccinations and Prophylaxis

Depending on the travel route, certain vaccinations are useful or even mandatory. Since some of these have to be administered in several individual doses at intervals, this should be planned for at an early stage.

[Tropical medicine institutes](#) offer tailor-made consultations and give travellers competent advice. The necessary vaccinations will also be administered there.

The tetanus vaccination should be refreshed as standard and a hepatitis A/B vaccination is also generally advisable. Other vaccinations such as yellow fever, typhoid and rabies should only be done on recommendation and/or when legally required. It may be easier and cheaper to have vaccinations done locally, but be careful, sometimes prove of certain vaccinations must be shown upon entry or it must for medical reasons be given before entry in order to be effective at all.

All vaccinations are noted on the [vaccination certificates](#). This is then also a valid document to prove the required vaccinations.

Malaria

Whether a drug should be taken prophylactically or just be carried as an emergency drug for self-medication in case of symptoms is the better solution depends primarily on the area to be visited. Since the medication requires a prescription, consultation with a travel doctor or a tropical institute is mandatory anyway.

Preparation



Figure 87 Malaria carrier, *Anopheles mosquito*
source: CDC, Public Health Image Library (PHIL.)

Malaria prophylaxis in the form of taking tablet doses before the trip is often no longer recommended nowadays, and if so, it is only recommended in high-risk areas. Instead, the appropriate medication is carried along as emergency treatment and is only taken when clear symptoms appear.

If malaria is widespread in the region you are visiting, it's better to be careful of yourself. It gets particularly tricky when you go to very remote regions with a pronounced risk of malaria. If there is no access to a reliable health facility within 48 hours, the only treatment option is to take emergency self-medication with you.

It is possible to carry a quick self-test on board such as "Malaquick". In case of fever attack and chills in a malaria infected region, a blood sample from the fingertip is analysed and an instant result is produced. But in any case if these symptoms occur, it is best to find a doctor for confirmation and treatment.

In any case, malaria should not be underestimate and it's important to seek relevant information well in advance. Once the parasite is caught, recurrences can occur over a long period of time, even if you don't put yourself at risk again.

The best and most effective prevention is still exposure prophylaxis. At least in the period from before dusk until after dawn, this means making sure that no parts of the body are uncovered, that insect repellents are used and, if possible, that you only stay in rooms with insect protection nets. You should only sleep behind mosquito nets.

Preparation

Travel Pharmacy and First Aid Kit

A first-aid kit tailored to the itinerary and duration of the trip should be part of the standard equipment of every Overlander. The family doctor or a travel medicine specialist can advise you individually.

What always belongs in the pharmacy are medicines and agents for the treatment of:

- Diarrhoea and nausea
- Pain
- Wound inflammation
- Travel/seasickness
- Sore throat and pharynx
- Flu/cold
- Bruises and sprains
- Minor injuries

Medications that require a prescription, such as antibiotics and strong painkillers, are useful for emergencies away from local medical care, but these have to be prescribed by a specialist who can provide assistance with selection, application and indication.

In addition, an extensive supply of disinfectants, bandages and plasters for the treatment of wounds and injuries belongs in the pharmacy. For frequent hikers with a tendency to blisters on their feet, appropriate protective plasters should be carried. Such plasters are hardly available in many countries.

Antiseptic eye washes and a means for moistening and disinfecting the eye help especially in dusty areas and when deserts are travelled intensively.

A clinical thermometer and good scissors should also be included.

It is useful to carry a selection of disposable syringes in very remote and rural areas, as these are not always readily available and the use of reusable syringes can pose a risk of infection.

Preparation

There are travellers who also have an emergency tooth repair kit with them. But since tooth damage is more painful than life-threatening, everyone has to decide for themselves whether it makes sense.

Depending on the medical expertise, the medical equipment can of course also be more extensive, not least if the local population is to be



Figure 88 Comprehensive travel pharmacy
(underway.ch)

helped in emergencies along the way. And if you carry a first aid kit / pharmacy you should, of course, make sure, you know how and when to use it!

Since the pharmacy is often exposed to dust, heat and other environmental influences, a correspondingly robust storage container makes sense.

Personal Medication

People who are dependent on certain medications should carry an appropriate supply with them. Contraceptives may also fall into this category! However, medicines that are sensitive in terms of shelf life and/or storage temperature are critical. In such cases, a consultation with the personal doctor should be made. In any case, a long-term prescription and possibly even a letter from the doctor with the medical history should be carried, if possible with at least a translation into English. This helps at the border if there are problems about the amount of medicine, or if you need medical treatment on the way, or if the medicine supplies have to be replenished.

When entering some of the countries, the import of certain medicines is restricted, prohibited or at least only possible to a limited extent. This is especially true for strong painkillers and psychotropic drugs, as well as opiates. Such products can, of course, be hidden and smuggled, but the consequences of discovery can result in severe penalties. It is unlikely that a traveller will be asked about such products at all, but a doctor's

Preparation

confirmation can help to explain the situation if the worst comes to the worst.

Test Journey

If a new vehicle has been procured just before the planned trip, a test trip that is as extensive as possible is highly recommended. Not only to get to know: the car, yourself, and to be able to test all functions extensively, but also to determine whether the equipment is complete and stowed in the right place. The route and travel time should be chosen such, that the expected climatic conditions of the planned "big" trip can be experienced. Only then can you test the function of the power supply, the water/wastewater system and the kitchen. If you discover pieces of equipment that have never been used, you have to question whether it makes sense to be taken on the long journey. Of course, this does not apply to repair material and items of equipment that have a clear and necessary function for emergencies.

If an off-road vehicle was bought and you don't have any practical driving experience with it, a driving course or at least practical training with the recovery material is recommended. There is not much worse than when jacks, winches or recovery boards are to be used for the first time when a critical, stressful situation has already occurred. The separate book from the author covers the relevant technical topics for overlanders travelling with a 4x4 (see link section at the end of this book).

Many travellers underestimate the time it takes to get a vehicle. This can mean, that the remaining time before departure is insufficient for a test drive and that any weak points and missing equipment are only discovered on the trip. This can sometimes lead to stress, especially if a correction is difficult or impossible to make in the region you are visiting.

Documents

Before the trip, some important documents have to be organized. This is best done just before the start of your trip, as many are only valid for a limited period of time.

Preparation

Passport

If the remaining validity of the passport is only for a short time, it should be at least for two years longer than the planned trip, or if there are only a few empty pages left, a new one should be applied for. This can also be useful if the current passport contains entry stamps from countries that could cause difficulties when entering future countries.



Figure 89 The passport will be the most important document on the trip (underway.ch)

A second passport would of course be helpful the event of a loss. If you have two passports, be sure to keep them separate and safely stowed away.

International Vaccination Certificates (WHO)

At the latest before a long-term trip, an international vaccination certificate document should be obtained. All vaccinations administered will be recorded in this form. The document is required in various countries as proof of mandatory vaccinations upon entry. The document is published by the WHO, and is issued and filled out at vaccination centres.

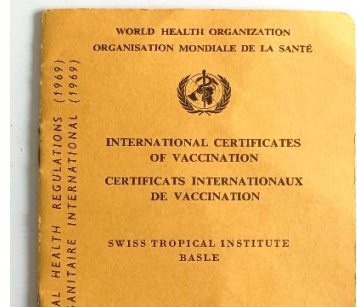

Figure 90 International vaccination certificates (underway.ch)

Preparation

International Driving Permit

In [many countries \(GE\)](#), as well as at car rental companies, this may be mandatory, even though hardly any police officer on the road will be aware of it. The international driving permit is actually only an official translation of the national driver license and is usually valid for two

years. Legally, it is only valid together with the national driver's license, therefore on request both must be presented during an inspection. In the event of a police check, however, it makes sense to only show your national driver's license or alternatively just a laminated copy of it, unless the officer explicitly asks for it. It should be noted that an international driver's license has a short validity period and therefore usually expires during a long journey. In practice, however, all this has little meaning, but a sly policeman can sometimes try to take advantage of the situation.

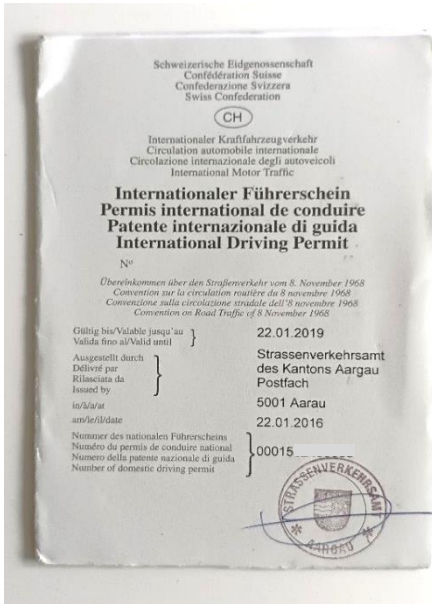

Figure 91 International driver's license (underway.ch)

The international driving permits are usually issued by the same body that issues the national driver licenses. But there is also an internationally accessible way to obtain the document [>LINK<](#).

Carnet de Passage

Some countries still require a so-called [Carnet de Passage](#) for temporarily imported vehicles. This document is used to guarantee re-export. Upon entry, the document is stamped by the customs authorities and upon departure, it must be ensured that customs also confirm departure. On the other hand, if the car would be left in the country illegally,

Preparation

the customs authorities would confiscate the deposit paid when the CdP was acquired. The CdP usually issued by a national automobile association. Or more precise, the national organisation that represents the [FIA](#) (Federation International d'Automobile). If you can't find a partner organisation in your own country, the [TCS](#) (Touring Club of Switzerland) issues a CdP to members and non-members incl. residents and vehicles from outside of Switzerland. In addition to the fee, a security deposit, depending on the value of the vehicle and the countries to be travelled, is also required. The deposit sum then remains in a blocked account until the correctly completed CdP has been returned to the issuer. This concept can have a decisive impact on the financing of the trip, because the deposit must either be placed in a defined blocked account, or at least as a bank guarantee, and will not be available during the trip. Cash or bank guarantee is decided by the issuer of the CdP. This is especially a problem for owners of a very valuable vehicle, because approx. 50% of the vehicle value is due, with the minimum value being \$10,000. There are also countries that require up to

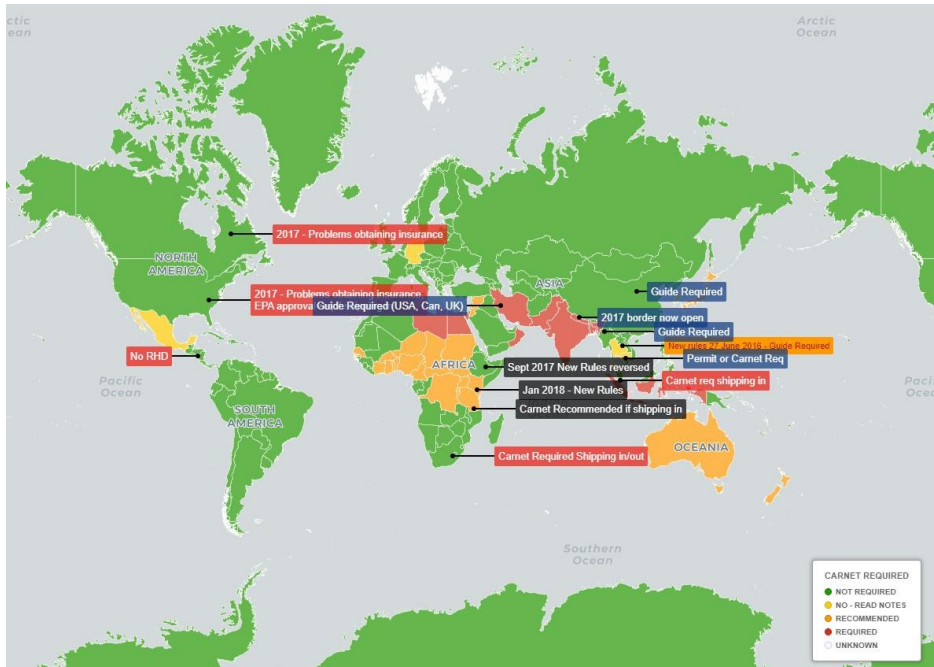

Figure 92 Carnet de Passage Worldmap (source: <https://overlandingassociation.org/carnet-de-passage/>)

Preparation

500% of the value, which means that if the CdP is also to be valid for such countries, the deposit will be correspondingly higher.

The CdP is valid for one year from the date of issue, but it can be extended en-route. Increasingly, however, countries are dispensing with the obligatory CdP and alternatively the customs authorities issue a "Temporary Import Permit" (TIP) at the border. Depending on the case, this document can usually entail a modest fee, but in most cases it is even free of charge. The permit clearly defines how long the vehicle may remain in the country, often based on the duration of the visitor permit of the owner. In some countries, the vehicle is simply entered in the holder's passport upon entry and deleted again upon departure, so it is not possible or at least complicated to leave the country without a vehicle.

Vehicle Documents and License Plates

This is an issue that is handled very differently from country to country. In principle, a document is always required at the border crossing, which confirms the vehicle owners and the vehicles identity. If you are bringing a second vehicle, such as a motorcycle, it is often easier if it is registered in the name of a second person, as some countries only allow one vehicle per person to be imported temporarily. If the vehicle documents are not in the driver's name, a [permit to use it](#) must be carried. For a similar reason, it is recommended to have a usage permit for the travel partner travelling with the owner for the case, that the registered person is absent, whether due to illness, home leave or the like. The same applies if the vehicle is registered in the name of a company. A special obstacle could be if a vehicle is leased. Some countries require extra paperwork in this case, but it is also possible that the leasing company, or a country, does not allow a leased vehicle to be brought out or in a particular country. This case requires consequent research beforehand.

According to generally applicable laws, the vehicle must be registered in the home country even if it is operated abroad, a requirement that is not always easy to meet. In every country, the formalities to maintain

Preparation

the registration of the vehicle have to be solved. Therefore, all travelers must deal with the topic and, if anything is unclear, seek a dialogue with the responsible authorities. This is usually the registration authority.

Document Copies

At least one, preferably several, paper copies of all important documents should be carried with you. It is worthwhile to have, beside the original vehicle papers, a hard colour copy that is ideally laminated, that you can show to the police.

Passport and vehicle paper copies are required in many countries, especially for border crossings and shipments. Some current passport photos should also be available, especially for applying for visas underway if necessary. Clarify at home which photo formats will be required. With an up-to-date digital photo that meets the general requirements, you can also have passport photos of any format printed out on the trip.

It is also useful to carry several copies of a multilingual form in which all the personal data of the people travelling and the vehicle data are summarized. In some countries, this can save a lot of time at regular traffic controls and avoid misunderstandings. Ideally, the form should also be in the local language.

An example of this can be found next to the "Overlander Handbook" download: [<LINK>](#)

Last but not least, all important documents should be scanned in good quality and stored in a cloud. In order to be able to send them by e-mail without any problems, it makes sense to also make a reduced-size copy of each file.

In an emergency, at least these copies are still accessible and, in the event of loss, they will significantly simplify and speed up the replacement of the documents concerned.

Preparation

HINT

If you have not set up a cloud, you can also send the documents to yourself as an e-mail attachment. This way, the documents in the mailbox remain securely available.

Finances

Getting Cash

Depending on the travel region, obtaining cash, especially large



Figure 93 Cash is always useful (*underway.ch*)

amounts, can be difficult or at least entail hefty fees. So, if cash is unexpectedly needed to pay a larger bill, it makes sense to have a cash reserve with

you. In most regions, US dollars are best accepted in notes that are not too large (20-100 dollar bills) in good condition, preferably new. In some countries it is even possible to pay directly with US dollars, or these can easily be exchanged for local currency. It is often possible to exchange money with private individuals or in shops, often at a better exchange rate. But beware, there are countries where this type of change is not permitted, so it is better to pay attention to the current local information. Increasingly, euros can also be exchanged for local currency on site, but it is best to check country-specific in advance.

In most countries, the import of cash is, if not limited, then at least subject to declaration. The declaration-free upper limit is usually the equivalent of around \$10,000 per person, so it shouldn't be a big restriction.

Preparation

HINT

It is advisable to hide the cash reserves in the vehicle well and in different places. A small safe on board often prevents the worst in the event of a break-in. The originals of the passports and other important documents and part of the cash can also be kept there.

Credit- and Debit Cards

The selection of the cards and the issuing bank will be decisive for the fees to be expected. That's why it's definitely worth making comprehensive comparisons to find out which financial institutions and which cards offer the most favourable conditions for use abroad. However, it should also be considered how easy it is to replace, block, or renew cards on the go in an emergency.

You should definitely have new cards issued before a long journey in order to avoid arranging new ones after a short time on the road. Not every bank sends the new cards abroad!! It also makes sense that several cards can be accessed, for example all adult travellers should independently have a Visa and a Mastercard, as well as a debit card. Lock away a set of cards and always use the same credit card. In the event of theft or misuse, only this one card needs to be blocked, and there are still other options at hand.

IMPORTANT

For security reasons, credit card companies block the cards if suspicious use is detected. This means that if a credit card is used contrary to normal usage behaviour, it is assumed that it has been misused and it will be blocked, often without even informing the cardholder in advance. This can be avoided by informing the bank about the travel plans in advance. In this way, you can also exclude countries you don't intend travelling to and thus further reduce the risk of misuse.

The monthly credit card limit must be checked before departure and adjusted if necessary. In the event of misuse, a limit that is too high means that the amount of damage can be correspondingly high. On the other hand, if the limit is set too low, it may not be possible to settle or withdraw sufficient amounts in an emergency situation. It is therefore

Preparation

necessary to check whether the limit can ideally be adapted to the situation abroad.

In the event of a card loss, the issuer must be informed immediately or the card must be blocked in order to limit the possible damage, otherwise there is a risk of joint liability. Replacing a card en-route is not always possible, or at least complicated. Here, too, it is worth clarifying the procedure with the bank in advance.

In general, a person of trust should be given the appropriate “Power of Attorney” for banking and other transactions at home so that they can act as your representative in your absence. This would also include receiving documents or new credit cards.

Although Internet banks offer very lucrative offers for credit cards and foreign cash withdrawals, it is important to remember that they do not excel when it comes to customer service. So, if something goes wrong, or stops working along the way, it can be very difficult to find a solution. Therefore, it is better to have an alternative up your sleeve when choosing an internet bank.

Money Transfer

With service providers such as Western Union, Transferwise (New: Wise) and other companies, money can be transferred to yourself, other people, and companies abroad. Since even large sums can be transferred in this way, this is an interesting option, especially in emergencies. However, it is important to know that access to an agency or local bank account is required and that is not very likely out in the bush, and in remote regions in general. When choosing the provider, not only the fees should be considered, but above all the accessibility in the region to be travelled to and, if necessary, the maximum amounts that can be sent.

If a provider has been found, you should register and set up access before you leave, because the user's identity will have to be clarified for this purpose, which could be more difficult on the road. If this is done

Preparation

before departure, the service can then be used on the journey without much effort.

A comprehensive and neutral article on the "[Wise](#)" can be found here: [>LINK< \(GE\)](#)

Money Transfer from Bank Account to Bank Account

What also works is an international money transfer from your own account at home to any account in the travel country. This can be a quick and also quite inexpensive solution to paying a large bill at a company, for example an expensive car repair or an expensive side trip. For this purpose, however, e-banking and the international payment option must be set up, something that is necessary anyway if bills have to be paid at home while away. Only the IBAN or other account details of the recipient and the currency have to be defined and the money should be transferred within a few days.

This option can also be used to transfer money to a local friend's account, from where they can withdraw it for you in cash. However, this is only worthwhile for larger amounts, and if there are no larger fees or restrictions somewhere.

Organize Banking Business

You might also have certain financial obligations while you are on the journey. Checking debit and credit card transactions, looking at bank accounts, possibly paying taxes and other bills, everything needs to be taken care of. Fortunately, this is no longer a problem nowadays, thanks to e-banking. If you haven't already set yourself up, now is the time to do it.

It is also ideal if a contact person is appointed at the home bank who can be reached directly by email and telephone. In emergencies and when something goes wrong, she can personally take care of it.

It is also very important to give a trusted family or friend the "Power of Attorney" to make transactions, make decisions and sign documents in your name if required.

Preparation

Since Internet banks offer very attractive conditions, especially in the credit card business and when trading in foreign currencies, these can be an interesting alternative for travellers. However, as these institutes are known for notoriously poor customer service, problems that arise can be difficult to resolve, especially in emergencies or when something has gone wrong. If you decide to use an online bank, it is advisable to have a plan B. It would be fatal if you didn't have access to your account on the go, and you could only communicate with the bank via chat or call centre, or not even that.

Obtaining Visas and Permits

If the start is in Europe towards Asia or Africa, sooner or later [countries](#) that require a visa will be approached. The validity of the issued visa is usually limited to a few weeks or months, so you have to think carefully about which countries you can, or should, already apply for at home. If there are delays in your journey after the visa has been issued, the expensive visa may expire, or the start of the trip is delayed because the inquiries were submitted too late, or the processing of the applications is taking a long time.

Basically, when planning the final trip, current clarifications on visa regulations and import or entry regulations of the individual countries to be visited should be made via the country representations. There are also various up-to-date [travel forums](#) that deal with these topics.

Organize Shipping

If the journey is to start on another continent or Oceania, the vehicle will have to be shipped. There are basically two options. The vehicle will either be shipped in a container or sent on a RoRo vessel (roll on, roll off). Depending on the destination, a Carnet de Passage must also be presented.

Shipping to the USA

If a vehicle is shipped to the USA, a document must be requested from the [EPA](#) in advance. The vehicle cannot be imported, not even temporarily, with-

Preparation

out this document. The selected carrier should actually be able to offer support on this.

Container Shipping

Container shipping is only an option if the vehicle height is less than 2.5m. If it is also too high for a Hi Cube container, there is only platform shipping left, which is very expensive and the vehicle is just as accessible, and therefore at risk of being broken into, as with a RoRo shipment. If the height is tight, the normal wheels can be replaced with small steel discs or old rims for transport. This allows you to gain a few centimetres in height. The exact container dimensions can be seen [HERE](#).



Figure 94 Container transport (underway.ch)

a Hi Cube container is required due to the vehicle height, a 40' long container is usually the only choice. On common routes and with the help of travel forums and experienced agents, it is often possible to bring together two people willing to ship together, provided that there is a certain flexibility on both sides with regard to the date, place of departure or destination and it is announced in good time.

A loading list is required for shipment in a container. This means that all items on board the vehicle must be listed with their current value, description and storage location. That can be a pretty long list for a fully equipped touring vehicle. However, it is not usually expected that everything is listed individually down to the last nut and bolt. It is useful if, for example, kitchen equipment or clothes are listed together in

In general, it can be stated that container shipping is safer and offers many more options for dates and routes. As a rule, however, the costs tend to be higher and the transit times longer and more uncertain. If a container partner is found to share a 40-foot container, the costs will be lower per party. If

Preparation

one item. At most, it is important that if clothes are stored in three different places, three positions are shown. The easiest is if the equipment is stowed away in boxes or cabinets. The places can then be numbered and listed with the contents and in the vehicle the boxes/door are numbered accordingly.

RoRo Shipping

There are some fundamental restrictions for RoRo shipments, which fortunately is not always (yet) enforced too strictly: Transported vehicles must be **EMPTY**, only original accessories and tools from the manufacturer are permitted. This is of course unthinkable for a traveler's vehicle. Even if this is not enforced, there is still the problem that if the vehicle should become the victim of a break-in, which can sometimes happen on certain routes, the shipping company and most transport insurance companies will not be responsible for the damage and loss. For this reason alone, no valuables (cameras, computers, etc.) should be left in the vehicle during transport. Since the car key must be



Figure 95 RoRo shipping (*underway.ch*)

handed in before transport, as the vehicle is driven on and off board by port personnel, the contents of the vehicle are at the mercy of potential thieves. In any case, it is recommended, if possible, to install a robust partition or door between the driver's cab and the camper part and to make all storage compartments, as well as access to the living area, lockable with a separate key. This is not a guarantee that nothing can happen, but at least prevents opportunistic theft. Sometimes the keys for the camper part and outside compartments don't have to be handed out, but some ports or custom authorities insist.

Meanwhile, there are RoRo connections between all continents, so that actually any vehicle can be shipped. However, not all ports in the countries are served by RoRo lines, therefore not all ports of departure

Preparation

and destination can be considered. This affects the arrival/ departure of the owner by plane as well. There were a few RoRo lines where you could travel as a passenger (e.g. North and South America with Grimaldi) on the vessel the vehicle was loaded. An interesting option, but with very limited capacity, so early booking is essential. Some shipping line have stopped this service during COVID and have not restored it yet.

IMPORTANT

*Just recently a more serious restriction has been put in place by some shipping lines. These will strictly **not** accept any vehicles with Lithium batteries inside. The reason is likely the various fire incidents on RoRo vessels in the past, where Lithium batteries are suspected to have been the cause of the fire.*

If your rig has such a battery you could think of trying to “smuggle” it on board, but this is strongly discouraged. The reason being is, that if it is detected at the port the vehicle will be refused! Not to talk about the very unlikely event of becoming the reason starting a fire on board. If the vehicle does make it onboard and the unreported “Hazardous Material” is found, hefty fines can be the result!



Abbildung 2 RoRo Netzwerk (Quelle: <https://www.walleniuswilhelmsen.com>)

Preparation

Above as an example, the worldwide routes of Wallenius Wilhelmsen, one of the largest RoRo providers.

With gas cylinders and tanks it is a similar issue yet so far not as strictly enforced.

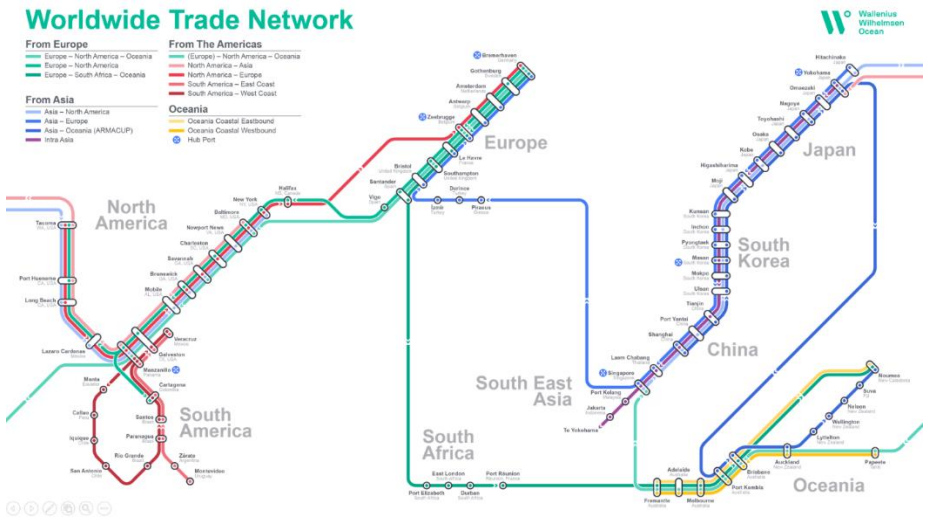
So, what is the solution? Vehicles fitting into a container can usually avoid these restrictions. But, sometimes a „Hazardous Surcharge“ is enforced, be it for gas cylinders or Li batteries.

General Shipping Information

Binding offers and timetables can only be prepared a few weeks before departure and both are anything but reliable. Both total costs and schedules, even the ship's itinerary, are subject to change without previous notice. This applies to RoRo as well as to container shipping.

A shipment is usually booked through an agency that organizes the entire transport. In some cases it is also possible to negotiate directly with the shipping company. However, it must be remembered that in addition to the actual sea transport, a large number of companies and authorities play their part, both in the port of departure, and in the port of arrival. These must be known, or found, in order to coordinate the entire process. Anyway, in many ports, the processing has to be carried out by an appointed agent. The services of an agent are usually worthwhile and the approximately \$300 fees per port are usually insignificant in relation to the remaining costs. Incidentally, the "additional costs" are often the larger proportion of the total price compared to the costs of the actual sea transport. It is therefore important to ensure that everything that is included in the offer is binding.

Still, there are possible cost items that pop up even after the transport is underway. For example if your container is selected for customs screening, a few hundred dollars. Surcharge for fuel price increase. Storage cost in the port because of delayed vessel. And there are quite a few more...

Preparation

Many Overlander have already fallen flat on their noses when the offered costs were then supplemented with surcharges or port fees at the destination. And a few travellers have obviously been ripped off. It is therefore better to stick to recognized, trustworthy agencies.

It might be interesting to read more about shipping terms and all the many potential surcharges. If so, explore here [>LINK<](#)

Transport Insurance

Transport insurance is usually offered as an option. This is intended to cover damage to the vehicle and, worst case, its total loss. The premium is usually a percentage of the insured value, 1-2% is common. A risk that is also covered is the cost-sharing of the recovery costs in the event of the sinking of the vessel. Yes, the customer has to share in the salvage costs of a shipwreck, unbelievable but true.

The customer bears almost all the additional costs of ship transport, even if the customer is certainly not to blame. Delays resulting in parking and layover times, ordered customs inspections, route changes with additional transfers, fuel price increases, etc. will all be billed additionally afterwards. A behaviour that would bankrupt most service industries is just plain normal in maritime transport.

In addition to some companies specializing in passenger vehicles, basically any transport agency can organize a shipment, but since vehicle transport is often subject to special rules, it is advantageous to entrust such a job to an experienced company. A selection can be found here: [HERE](#)

Even if a shipment is only planned well into the trip, it is worth making contacts before departure and finding out about the procedure so that the organization can be managed more easily on the way.

Attention, Gas on Board

As mentioned above, a general problem with shipments are gas cylinders and tanks. In the case of container shipping, the freight would then become dangerous goods, which would result in heavy price surcharges. But RoRo may

Preparation

also have rules that generally prohibit gas containers, or require expensive nitrogen flushing. Anyway, if you are equipped with bottles, it is important to consider whether or not they would be better left at home and new bottles procured at the destination.

In any case, appropriate adapters for connection to the installed gas system or to the usual on-site refuelling equipment must be carried along. Valuable information and assistance can be found in the ["Cooking Gas Around the World"](#) Facebook group. [Wynen Gas](#) (GE), based in Germany, is also a good source when it comes to worldwide gas systems and adapters.

If you would like to read more background information on the subject of "shipping", the extensive article in English by "Landcruising Adventure" is recommended: [>LINK<](#)

Flight Tickets

If the vehicle has to be shipped, and you cannot travel on the same ship, you must of course also take care of your own journey. As mentioned above, the ship timetables are anything but reliable. This means that if you choose a flight before the planned arrival and the ship arrives late, you will quickly have to kill a few days, or even weeks. Then, of course, there are unexpected costs for accommodation and meals. Under certain circumstances, it can be worthwhile if the departure can be postponed at short notice. But of course that means that you still have to have a place to live somewhere at home, and the reserved accommodation must be rebooked. In any case, it is less likely that a ship will arrive earlier than expected, and the unloading and its formalities often take a few days. So you can put your own arrival on the expected arrival date of the ship, or even the following working day. That all sounds logical and actually makes sense. But most travelers can hardly wait and just want to get started. That's OK too, but you should keep the scenario above in mind.

The author himself experienced a delay in Halifax of more than a week, and is by no means the only one to whom this has happened, and therefore had to change accommodation because the reservation could not be extended at short notice. He took this into account when

Preparation

shipping to Colombia and organized the arrival two days after the scheduled arrival. In the end, however, the recollection was delayed again because of a weekend followed by a public holiday.

Another point to consider is that you usually do not need a return flight because neither the date nor the place of the return journey is known at the start. In addition, return tickets are only valid for one year anyway.

However, there are two reasons why buying a return ticket still makes sense:

1. Many countries require a valid return ticket upon entry as proof that you are not staying in the country. If you can prove that your vehicle is on its way and you will leave the country via land border it should not be an issue.
2. Return tickets are often cheaper or only slightly more expensive than a return flight. If the return part of the ticket can be cancelled you might be able to get a refund, although this normally only possible for more expensive tickets anyway.

If you want to be on the absolutely safe side, you can also buy a onward ticket from a particular [online company](#) and cancel it after entering the country. This service does not cost the world.

Mail

As a rule, in most countries mail can only be forwarded or retained for a certain period of time. The easiest solution is to redirect the mail after your departure to another address. Ideally, this is the same address as the correspondence address, which should definitely be set up for other tasks as well.

In order to be able to receive consignments that have to be acknowledged with a signature, it is necessary for a person of trust at the address to have the necessary power of attorney.

Some postal services might offer digital solutions for letters and documents. With this service, documents and invoices can be received elec-

Preparation

tronically wherever you are. The postal service will open the documents, scan them and forward them electronically to the recipient for a fee. This service is particularly useful for dealing with the correspondence of ongoing obligations, for example insurance, banking, subscriptions, etc. However, since other, perhaps even unwanted, letters may be sent too, the costs cannot be foreseen.

Terminations

In normal life you will have entered into a wide variety of obligations and contracts. Most of them will no longer be needed during a long journey and must therefore be cancelled in good time. Since the liabilities are very individual, here are just a few topics as a reminder:

- Subscriptions, telephone, magazines, television, etc.
- Club and association memberships
- Insurances
- Job, housing, electricity, gas and water, etc.

It is best to start a checklist early in the planning of your trip, including termination reminders. Owners of real estate should check whether the current mortgage runs beyond the duration of the trip because it will be difficult to extend or renew it away from home.

Experience shows that the last few weeks before take-off are the most stressful for most Overlander. Much of this can be avoided with appropriate careful planning, however, there will be plenty of surprises anyway.

So, now everything should be ready for the big trip, all that remains is the “fare well party” and then saying goodbye to family and friends....



Underway

Obtaining Travel Information

The experience of many travellers shows that once you are on the road, less time and effort is put into obtaining travel information. That's OK, because spontaneous experiences and surprises should definitely be given enough space.

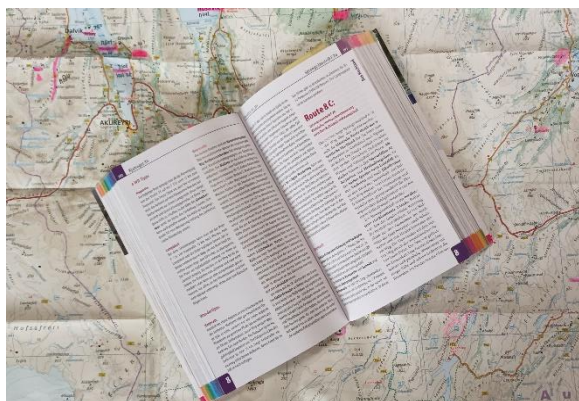

Figure 96 Guide books are a good planning source
(underway.ch)

Nowadays, thanks to the Internet, it has actually become incredibly easy to research the further course of the journey on a rolling basis, even while travelling. It is hardly possible to take all the travel guides books with you from home for a world trip lasting several years, and by the time the last ones are finally needed, they are no longer up to date. But you will always meet Overlander from the opposite direction, and cross the paths of others over, and over, again. It's an opportunity to exchange travel guide books with them, which ultimately benefits both.

Information on current needs such as shopping, garages, places to stay and the like can be found quickly, up-to-date and conveniently with the relevant apps or on the Internet. Sources of information that should not be underestimated are of course other travellers. You can meet

Underway

them easy in classic Overlander hotspots, which can be found all over the world. Such places are widely known, and the corresponding information is gladly passed on. What could be nicer than sitting around the campfire with like-minded people and exchanging experiences?

The [methods described](#) in previous chapters, on how to collect information with the help of Google Maps, can also be used to continue this process on the journey, and incorporated into short- and medium-term route planning.

The well-known websites and apps are best suited for obtaining information about current rules, restrictions and procedures at border crossings because they are kept up to date by authorities and other travelers. ([see chapter at the end of the book](#))

Withdraw Cash

Technically, withdrawing cash in local currency is no longer a problem in most countries today, as there are large numbers of ATMs in any larger cities. However, disadvantages and problems can also arise, so it should be ensured that sufficient cash reserves are always available.



Figure 97 Getting cash can be a challenge ([underway.ch](#))

Withdrawing money is usually easily possible with a debit card, as well as all common credit cards. However, ATMs rarely accept all types of cards. There are usually fees for all types of cards, with credit cards usually

significantly higher. In addition, the operators of the ATMs may also charge additional, sometimes exorbitant, fees. It is not uncommon to experience up to 15% of the funds drawn to be included in additional costs. This is all the more relevant the smaller the maximum possible withdrawal amount is.

Underway

The maximum amount that can be withdrawn per day and card varies from country to country, often also between banks, but it's never very high abroad, at best the equivalent of around \$300.

The following website shows which banks charge which subscription fees in a certain country: [>LINK<](#) (GE). As you can see, before entering the country, it is worth researching on which bank you should preferably get cash from.

Another possibility, especially for larger amounts, are companies like Western Union or Wise. You can register spontaneously on the go, but it makes sense to select the provider before you leave and to make sure that everything works. This type of money transfer also incurs fees, usually as a percentage of the amount transferred

Paying with Creditcards

Credit cards can now be used in almost all countries in the world. However, mostly only in touristically well-developed regions and in large, modern shops. However, they are not accepted neither at a bush service station, nor at the local vegetable market.

When shopping in supermarkets, filling up at service stations with major fuel brands, in online shops, even when buying ferry or plane tickets, or in shops of large chain stores, you shouldn't have any problems paying by credit card. In countries like the USA or also in most European countries, up to 90% of expenses can be settled with credit cards. In poorer countries the proportion will be significantly lower, but if fuel costs can be paid by credit card it will make up a considerable proportion of the total costs, and the daily expenses for food and accommodation are usually quite cheap in such countries. Thus, the total cash requirement is manageable. Much more than a few hundred dollars a month is hardly needed.

However, you have to be aware that in most cases, every credit card transaction abroad is charged with fees from the issuing bank. Depending on the bank and the country in which the card is issued, this can add up to 2%. A considerable sum accumulates on a journey lasting

Underway

several years, but compared to the overall budget it is probably acceptable. The additional security and flexibility also has an equivalent value.

Photography and Filming

Once on the move, hundreds, if not thousands, of pictures will be taken. When photographing people, you should act respectfully and responsibly.



Figure 98 Taking pictures of people requires respect and distance (*underway.ch*)

Certain cultures generally prohibit photographing people and that deserves to be respected. In other regions it is common that you will be asked to pay for the permission to depict something or someone. If you have a problem with that, you should not take pictures at all.

If the images are to be used professionally, for example in presentations with an entrance fee, or as stock photos that are subject to a fee, the photographer is legally obliged to have written consent from the people depicted, otherwise in the worst case you have to expect a lawsuit, or the images will certainly not be allowed by any professional image databases.

Whether you take photos with a mobile phone or professional photo equipment, some questions are the same:

- How can I improve the picture quality?
- How do I keep track of the many pictures?
- How can I save and back up my data?
- What do I want to do with the image material anyway?

Underway

Editing the Material

Both images and videos will have to be edited or cut for ambitious or professional further use. The effort, especially for videos, is considerable and requires both the appropriate equipment and specialist knowledge. Ideally, you should bring both with you.

If you want to get involved in post-processing, you should always shoot pictures in RAW format, because this offers the best conditions for high-quality post-processing. This is especially so if the plan is to project onto a large screen; no compromises should be made in terms of resolution and image quality, and the same applies to videos.

It is also very important to delete the bad pictures as you view them, and to tag the remaining ones with keywords. This is the only way that images can be sorted, or searched for, in the future, based on content and/or geographical connection. Editing thousands of images afterwards is a gigantic task and almost impossible to master.

Data Saving and Back-Up

If you want to ensure that the pictures taken are not lost, you should follow a sensible workflow. The most minimal precaution is that the images from the camera/mobile phone are regularly backed up in a cloud or, even simpler, on an external storage medium. This is the only way to prevent all images from being lost in the event of theft or a defect in the camera.

Images should be transferred from the camera to another storage medium on a daily or weekly basis, but certainly regularly. After sorting and editing, the photos are copied to cloud storage or, more practically, to a separately stowed away hard disk.

There is a catch to backing up the images in a cloud. The amounts of data are gigantic, especially when you take high-resolution pictures, and it is almost impossible to upload them via public Wi-Fi. You also have to consider that the free storage capacities of the usual providers will in most cases not be sufficient to save all the pictures from a long journey.

Underway

If images are also going to be used for a website, it makes sense to save the selected images after editing with a resolution sufficient for the screen display. This saves loading time both when uploading to the website and later when viewing the images.

Legal Aspects

Even before entering a new country, you need to find out whether there are any legal restrictions on filming and photography.

Photographing strategic and military objects is usually strictly forbidden and can have very serious consequences if not obeyed. What may not be photographed is often not very clear and the assessment is often at the discretion of the controlling authorities. Therefore you should be more reserved and discreet and ideally, if possible, ask explicitly right away. What certainly falls under these restrictions are border stations, military and police facilities. But port facilities, airfields and even bridges can also be included.

As already mentioned, drones in particular and their use are often strictly regulated. Even the import can be prohibited, or you need a permit that is not only difficult to obtain or expensive, but you may not even know who to contact.

Navigation

Finding your way in unfamiliar areas is one of the challenges of travel. Luckily, you no longer have to deal with unreliable, large-scale street maps, although these are still very useful for maintaining an overview and for rough planning.

Modern travellers today rely on GPS navigation. If you travel in well-developed countries and mostly on main roads, the digital maps that are already stored on the GPS device or that can be bought additionally are usually sufficient.

For all other cases you need alternative map solutions. The most widespread map basis and also the one with the best content is the freely accessible map project Open Street Map. Thousands of users help to update and complete the existing maps through voluntary work. Espe-

Underway

cially areas that are interesting for tourism, there are usually no better map alternatives and since Overlander in particular also play a key role in mapping, interesting routes and points of interest (POI) for travellers are well documented. It is therefore also desirable that travellers who travel on routes that have not yet been mapped, or discover POIs that have not yet been published, add these to the OSM. It's not that complicated. After setting up an account, you can already become active after a short period of familiarization.

Navigable OSM maps can be downloaded and e.g. transferred to a normal Garmin GPS. As the data volume of the maps is considerable, it is best to download them when good Wi-Fi is available. Search for "openstreetmap free download" to get various options. Another tool is very helpful in this context, because if several maps are to be used on the same navigation device, or in software tools such as Garmin's Basecamp, they must first be named individually after downloading. All the necessary work can be done with the tool [JaVaWa](#), which is also downloadable for free. This program also contains the necessary instructions in the application itself. The website offers interested parties many other useful tools in connection with digital maps.

A comprehensive article is also devoted to this topic on the underway.ch website: [>LINK<](#)

Most navigation apps use Open Street Map in the background, so you will not notice any relevant difference between the individual products in the map contents. However, there are differences in the appearance of the maps. For example, [Mapy](#) offers a very clear map image, and contour lines are also included. In order to have alternative map bases available, which makes sense, you should choose other applications that are independent of OSM maps. This includes, for example, Google Maps or Here. These are based on their own map services, which is sometimes better than OSM, but is always less detailed in third-world countries. Another advantage is that satellite maps are also available, at least in online mode. However, this only helps if you can count on good GSM coverage and a corresponding data quota is available.

Underway

Google Maps can only be used offline to a limited extent. To enable this, you first have to download individual regions of interest online.

Search for places to stay

The most beautiful thing is, of course, when you can spend the night undisturbed in a secluded spot in the great outdoors. However, this is not possible everywhere, be it for security, geographical or legal reasons. On the other hand, camping infrastructures are often simply not available in all countries and regions. Therefore, on a long journey you may have to deal with the search for a suitable, and preferably nice and safe, place to sleep quite often, if not every day.

Over time, a feeling will develop for how a suitable place can be found spontaneously. If you don't already have a concrete plan, you shouldn't start your search too late, but be on the lookout at least 1 - 2 hours before sunset. It is advantageous if the place to stay is located far away from villages and dwellings and also not visible from busy roads. This is especially true if there is no wish for unwanted visits. But of course it can also be attractive and an interesting experience to find a place right in a village. Your best bet is to check with the local police or a trusted resident for options. Depending on the region, however, one cannot expect locals to know what a traveller needs for a good place to stay.



Figure 99 Lonely bush camp in Alaska (*underway.ch*)

If you are travelling with an active GPS satellite tracker, you should be aware that there is a risk that a “bad boy” might use the information to pay an unwanted visit to your camp. This is best avoided, by restricting the online access to the data, e.g. by placing the map with your online track and location on your website, hidden behind a password access that is only known to trusted people. This measure is particular-

Underway

ly important if your website is dominantly posted in public, e.g. on your vehicle.

And then of course there are also helpful sources of information in the travel community. Meanwhile, interactive apps are the most common way to find a place to sleep. Be it a camp away from it all, a secure parking space at a service station, or a commercial campsite, there is usually a solution. It makes sense not to rely on just one source, but to have several alternatives ready. This is especially true in regions where wild camping is rather difficult, or if there is generally little tourism. Popular tools can be found here [>LINK<](#)

In any case, one should adhere to prohibitions and respect private property. Even if you manage to spend a night in a forbidden place unnoticed, you won't make any friends with subsequent Overlander if they find nice places cordoned off, or the local population behaves dismissively.

Waste and toilet issues

Taking your rubbish with you and going to the bush toilet "without a trace" should actually be a matter of course.

If you don't have a toilet in your touring vehicle, you burn the toilet paper in the dug hole, and then cover your business, but if possible without burning the surrounding forest down. Unfortunately, there are always wonderful places to be found where exactly these things cannot be taken for granted. Garbage, shards, toilet paper in the bushes and smelly "land mines" everywhere you look; these are indeed very unsavoury relics.

So it shouldn't come as a surprise that wild camping is being banned in ever more regions. Overlander can lead by example by clearing a polluted place of garbage!

Cooking and Baking



Figure 100 Gourmet food underway, Cordon Bleu with cactus and fried potatoes (underway.ch)

Having time to cook well and healthy is a traveller's privilege, but it does not have the same importance to everyone, neither is everyone a gifted cook. However, given the necessary interest, and a certain curiosity, it is also an interesting experience to enrich the kitchen

with local products and recipes. In many countries you might also miss the fine, crusty bread from the local baker and might like to try it yourself.

It is part of traveling to stock up on groceries at local markets and local shops in order to prepare tasty meals. The presentation of the goods will not always meet the usual standards, but with a few precautionary rules and procedures, major breakdowns in the digestive tract can be avoided.



Figure 101 Tropical fruit from the market (underway.ch)

The rule for fruits and vegetables "Peel it, cook it, or forget it" says most about the topic. But you don't have to generally do without a green salad or a juicy tomato. However, you should wash the food thoroughly with safe DRINKING WATER before eating it raw. If the food is cooked, you can't

Underway

really go wrong anyway. The safety of eating meat can be judged fairly well, yet not always, by its appearance and smell.

Whether it is then, however, as delicious as expected is written on another page. In other countries, the meat is often cut and sold completely differently. This means that you will have to do without many of the dishes you are familiar with from home. But for a stew it is less important how the meat comes along. Whenever possible, minced meat should be processed fresh, so not only can you see what's inside, but you can also be sure that it's fresh

If you are set up for baking, but do not always want to make boring white bread, you will have to try to get other types of flour and possibly also cereals and seeds. This is not always easy and often expensive in countries without a "Central European bread culture", so if you have a good opportunity to shop for it somewhere, you should stock up. However, white flour and yeast can be obtained almost anywhere without difficulty.

The same applies to muesli lovers, by the way. Creativity is required for the basic ingredients. Even rolled oats are not easily available everywhere and if so, then they are often rather expensive. On the other hand, you can often add excellently good fruit at very reasonable prices.



Figure 102 Fantastic cheese maker in Mexico (*underway.ch*)

Sausage products, cheese and other dairy products are often not available in European variety and quality. It's all the nicer when, after months of traveling, you come across the bakery or butcher shop of an emigrant with European roots. Incidentally, such addresses are traded

Underway

openly among travellers and are often also published in the iOverlander app.

Allergies and other Restrictions

An ever-increasing proportion of the Western population suffers from one or more food allergies or intolerances. In addition, there are self-imposed ethical, ecological or religious restrictions. Depending on the region, this can make life very difficult or at least make travelling a little bit more complicated.

This customer desire cannot easily be satisfied on all continents and therefore one cannot count on shops and restaurants being aware of the problem and therefore lack the expected offering.

If you cook yourself, and primarily with fresh products, the problem is less serious, since you have personal influence on the products and can at best ask about them when shopping. However, "exotic" ingredients are often not easy to find and the more remote a region, the smaller the selection. But those who have learned to live with these limitations for a long time will be able to get by anywhere without starving or getting sick. But a certain adjustment or limitations of the offer will have to be accepted.

For the most part it certainly makes sense to keep a supply of well-tolerated, long-lasting food on board. When eating in a restaurant or at a street stand, you will have to explicitly inquire about the subject.

Drinking and Waste Water

The bunkering of large amounts of water and the later, environmentally friendly disposal of the waste water are a major challenge in countries without a camping infrastructure, for black water disposal, i.e. the toilet outlets, even more so.

Perfect drinking water is not a matter of course in many places and therefore the vehicle must either be equipped with a filter system, or bottled water must be bought regularly. However, bottled drinking

Underway

water not only costs a lot of money and requires a lot of storage space, but the unavoidable waste is of course also an environmental burden.

Filling a large water tank can take a long time due to the often low line pressure and flow, and occupies the tap for a long time. Without the appropriate infrastructure, it will also be difficult to dispose of large quantities of grey water. Grey water is usually little polluted and can also be disposed of in small quantities in nature while avoiding surface water pollution, or into the sewage system. However, this is not an acceptable solution for toilet disposal.

Vehicle Maintenance

On a long journey, vehicle maintenance will sooner or later become due. If you have a vehicle model that is common in the region you are visiting, it should not be a problem to find a competent garage to have them do the work. With "exotic" models or in less developed areas, this can already be a challenge.



Figure 103 Maintenance work in Bolivia ([underway.ch](http://www.underway.ch))

In any case, it makes sense to be able to carry out the most important work yourself or at least to have enough knowledge to supervise and support the work of a mechanic. There should also always be enough spare parts on board to be able to replace the necessary parts, such as filters. Garages are usually very helpful to travellers, but great enthusiasm is not always a guarantee for specialist knowledge. One should therefore try to accompany the work without appearing as an arrogant know-it-all. With a little empathy, however, this works well and the mechanics are often proud to be allowed to work on such a great vehicle.

Underway

It is often common for customers to bring all the service material with them, but the workshop will certainly know of sources to buy it for the work to be performed. Under certain circumstances, however, it must first be procured from outside, which can lead to delays.

The same applies to any repairs. Many trustworthy garages are listed in the relevant travel apps, above all iOverlander. However, you should plan upcoming maintenance in good time, and if on-board consumable parts have to be used you should arrange for a replacement at the next opportunity.

Bordercrossings

A principle when crossing borders is to behave in a respectful and friendly manner when dealing with the authorities. This even so if the way of working and organization does not correspond to the standards known from home. In addition, you should appear in "decent" clothes, so better not in slippers, torn shorts and topless. Female travellers should also adapt to the customary local conditions, especially when in contact with authorities, even if that doesn't make any sense to you or it's difficult to accept.

If you raise your voice about alleged mishandling, it certainly won't do you any good, but it will almost certainly slow the progress down. The authorities always have the upper hand and this can be clearly shown to you.

At most borders, there are two, sometimes three, steps to be taken when leaving the country and when entering the upcoming country:

- The border police (Police, Polizia) regulate visas, passport controls and, in general, the entry and exit of people. Often an entry/exit form has to be filled out first.
- The customs authorities (Douane, Dogana) will, based on their decision, check the goods being carried and clear the vehicle. It will therefore also stamp the Carnet de Passage, or delete/reissue the Temporary Import Permit.

Underway

- Sometimes you have to declare groceries when entering the country, if certain products are only allowed to be imported to a limited extent, if at all. A separate authority is often responsible for this. It is important to do some research beforehand to avoid having freshly bought food confiscated at the border.

Pets

If you are traveling with pets, it is important to clarify in advance whether there are any formalities that need to be completed before crossing the border. It is common, for example, to obtain a health certificate from a recognized veterinarian. In some cases, however, the animal must also be registered in advance via the Internet.

The best way to find out where you have to do what, and in what order, is to ask one of the uniformed officials for support.

General Information

It is important to have all the necessary documents, some cash and writing materials ready before entering the border station. If you are not familiar with the circumstances and formalities, it is recommended to first ask someone in uniform for help. "Helpers", they often offer at border stations to help you through the immigration process, can be helpful, especially if the situation is confusing and if there are language barriers. However, one should clarify in advance what costs are to be expected for the assistance. Passports and vehicle documents should only be handed over to such people, as well as to officials, if it seems absolutely necessary. And if so, then you have to try to keep an eye on the papers.

Insurance and Cash

You often have to take out local vehicle insurance at the border. The companies have usually set up their own counters or offices for this purpose. For the insurance you will likely need cash, maybe even only local currency is accepted. If you don't already have the relevant currency at hand, it means you have to change money at the border. Since you are stuck in a forced situation, the exchange rate offered is often

Underway

not favourable. In order to get a feeling for the correct rate, you should find out about it on the Internet in advance. You can often withdraw cash in local currency from an ATM, but there too, often with high fees and a poor exchange rate.

Before continuing your journey, it is worth checking again whether you have all the documents back, and whether all forms have actually been filled out correctly. Wrong numbers, passport or chassis numbers in particular, but also date and names can lead to complications later when leaving the country.

Obstacles to the import of vehicles

In some countries, in addition to the usual bureaucratic hurdles, there are also a few fundamental obstacles to consider. There are some countries that do not allow right-hand or left-hand drive vehicles into the country, even if only temporarily, or special rules may apply.

The current restrictions can be viewed on an interactive map on the Overlanding Association website

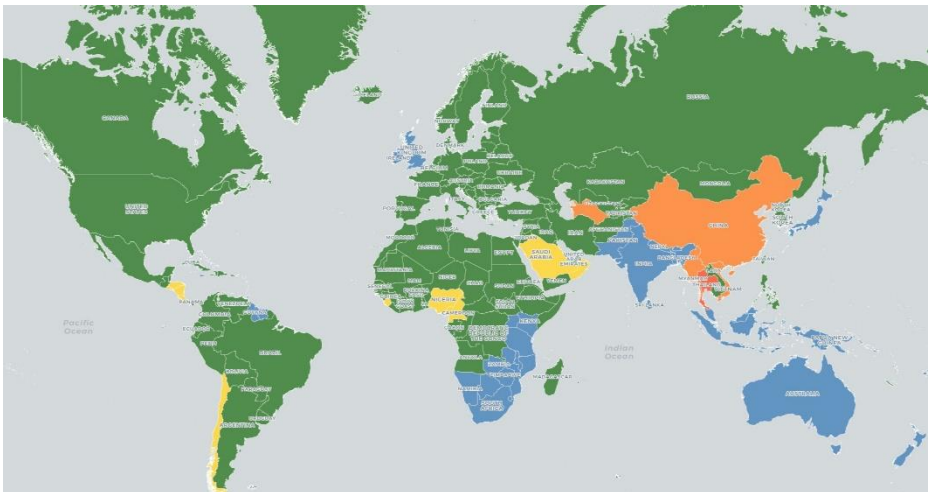

Figure 104 Left / Right hand traffic and its restrictions (source:<https://overlandingassociation.org/lhd-rhd/>)

Temporary Import of the Vehicle

In most countries, the temporary import of a vehicle involves more or less bureaucracy. The background to this is that the customs authorities want to prevent the import of a duty-free vehicle.

Usually, the authorities resort to the so-called TIP (Temporary Import Permit). When crossing the border, a form is filled out with the vehicle and owner data. This must be presented at the time of re-export in order to confirm the export. Often, the data is also entered into a computer system and deleted again. Depending on the country, however, the vehicle is also, or additionally, entered in the owner's passport and deleted again when leaving the country. Costs for temporary importation are usually not to be expected and if there are, the fees are usually not high.

One possible source of information on this topic is the interactive map of the [Overlanding Association](#). However, it is essential to inquire locally to up-date the applicable rules, because the rules and regulations can change at any time.

If you travel with a Carnet de Passage, it serves exactly the same purpose. The countries in which a CdP is necessary or advantageous can be found in the chapter "[Carnet de Passage](#)".

WARNING

The validity of the given TIP must be respected. Failing to do so, may end in confiscation of the vehicle or hefty fines. If you find yourself in the situation that the TIP is going to expire before crossing the border, you must contact the nearest customs authority, inland there is normally an office at international airports or harbors, to see if it is possible to extend it.

In any case inform yourself about the rules and options before you let the TIP expire.

If you intend to sell your vehicle under a TIP, be also very careful. Selling to a resident is usually impossible or complicated and very expensive.

Underway

sive processes are required. Selling to another traveler is sometimes easier yet again the paperwork has to be taken care of. See chapter [“Buying a Vehicle away from Home”](#)

Home Leave

More and more long-term travelers are planning a home vacation from time to time. In this case, it is important to find out exactly what needs to be done for the vehicle to remain legal during the absence. In some countries, it is generally not allowed to leave the country without the vehicle. Other countries only allow it if the vehicle remains under lock and key in a duty-free warehouse. But even if it is not explicitly forbidden to leave the vehicle behind, the validity period of the TIP must be respected in any case. In concrete terms, this means that you have to be back in time in order to leave the country with the vehicle on time.

Even if the customs and immigration authorities do not exchange data everywhere, it is risky to leave the country without a vehicle if it is forbidden, because the consequences can be serious if you are caught (see above).

The validity period of the TIP varies considerably depending on the country and can range from 30 days to a maximum of one year. Often, the deadline is also based on the owner's residence permit. For these reasons alone, it makes sense to plan your home holiday in such a way that you start it in a country where it is possible to leave the country without a vehicle and where the validity of the TIP is sufficiently long. In some cases, it is also possible to extend the TIP. Depending on the country, however, you may have to apply for an extension from the customs authorities before the expiry of the validity or a local contact person can do this on your behalf.

Similar rules apply to overlanders travelling with a Carnet de Passage. However, the regular validity is one year from the creation of the document and this can usually be extended again and again for another year. But even in this case, you should carefully clarify in advance how the formalities are to be organized.

Underway

Telephony and Internet

If you have not decided on a SIM card that can be used globally, you will have to try to find a local solution after crossing the border. In many countries, SIM cards and the corresponding pre-paid plans for data and telephony are easy to buy everywhere and usually very cheap.

However, there are two obstacles to be considered in some countries:

- Sometimes a complicated procedure is necessary to register a SIM card.
- The registration, and also the subsequent purchase of credit, takes place via the provider's website, and this may only be offered in the national language.

In both cases it is easiest and safest to get help from the seller. Since, among other things, identification of the buyer is required for registration, it must be ensured when purchasing that the passport is present.

Public Wi-Fi access can be found in ever more regions. Shops and restaurants in particular offer their customers Wi-Fi, but you often have to register first, which is not a big obstacle, even though a cell phone number is often required.

Wi-Fi's in campsites are often slow and quickly overloaded when too many users log on. Furthermore, the signal strength is not guaranteed in the entire area. It is therefore worth checking the signal of the network when looking for a suitable campsite. Otherwise, the previously described [amplifier antenna](#) can be used in such cases.

Police and Military Check-Points

Police checks are mostly friendly and correct. As a traveller you often have an advantage and are treated courteously. In any case, you should be respectful and friendly when dealing with the police or military. The officials are doing their job and it is not up to travellers to question the usefulness, even if this may appear to be the case from your point of view. Searches of the vehicle interior are often just a re-

Underway

sult of curiosity to take a look at such a great vehicle. However, it cannot be ruled out that a “black sheep” might use the opportunity to steal. You should therefore always accompany the search.

It gets tricky when you are stopped by corrupt officials. They want to foist a misdemeanour on you, or simply put a fine, maybe even a legitimate one, in their own pocket. If you are certain that you have not committed an offence, you should represent this point of view in a friendly, and always respectful manner. However, if the officer continues to insist, it is best to play for time, for example by pretending not to understand what is being asked of you. Before paying, you can also ask the official to write down the fines on an official form or at least to get a receipt for them. It can also help to ask the police officer to be allowed to contact your own embassy in the country by telephone, since you do not speak the language well enough to understand what he wants. Sooner or later the police officer will get tired of it and he will let you go. What you should definitely avoid is fulfilling an obvious request for a bribe, or even worse, attempting a bribe yourself.

In many South American countries, which are aware of the corruption problem, fines are always paid in a bank, and never paid in cash on the street. Even if you don't, you may be able to get out of trouble by claiming you don't have enough cash, having an almost empty wallet ready to show, and asking the police to direct you to a bank where you can get cash.

Getting additional Visas and Permits

On this topic, it is important to clarify in advance which visas you can, or even must, obtain at home. There are countries for which you can only apply for a visa at the embassy in your home country. In most cases, however, it is also possible to apply in a neighbouring country and often even get the required visa faster and cheaper.

The most up-to-date information is found in the relevant forums and Facebook groups, because visa procurement is an ongoing topic and the situation is often changing.

Underway

A popular source for this is the [Overlanding Association](#).

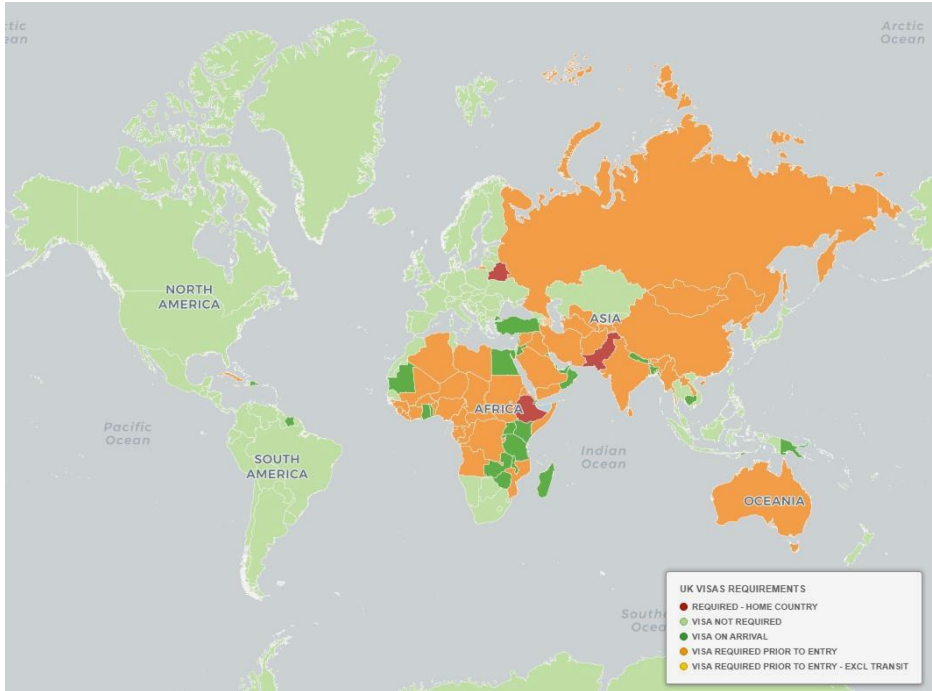

Figure 105 World map with visa requirements (source: <https://overlandingassociation.org/visas/>)

If it is not possible to obtain a visa away from your home country, you should try to find a visa service company. Maybe they can help you by applying in your name. This also is not always possible and you would have to send the passport home for processing. This will take quite some time.

The Carnet de Passage also expires after one year and must be renewed. How this can be done is clearly shown on the [TCS website](#).(GE)

Organizing Vehicle Shipping

If shipping becomes necessary en-route, this can be organized without difficulty. If it is not the first shipment, the relevant contacts and experience will already exist; otherwise it is also possible to organize it on the go without any problems. The lead time should be a few weeks, since prices and departures are only known one up to three months in

Underway



Figure 106 Container loading in the harbour
(underway.ch)

advance anyway. The most common routes are served weekly or at least monthly.

Be aware of restrictions regarding Lithium batteries and gas containers. Details here: [>LINK<](#)

Safety

Few travellers find themselves in serious, life-threatening situations along the way. Petty theft and vehicle break-ins are the most common of the potential problems. Life and health are very rarely in danger. Over time you will develop a “gut feeling” for possible dangers, but you should not be paranoid, it spoils the fun of traveling considerably. With a few simple precautionary measures, the risk can be further reduced.

Driving at Night

Actually, under normal circumstances, there is no reason to travel at night. The dangers of driving in the dark are not of a criminal nature, but mostly in the form of unlit vehicles, careless people and animals, but also poorly visible potholes or other obstacles. At worst, certain quarters in large cities can be tricky. You should definitely avoid them, especially at night. You have to do some research beforehand to avoid nasty surprises.

If, for whatever reason, it is unavoidable to be out and about at night, you should drive carefully and slowly and be prepared for surprises.

Wild camping

There are areas where it is better to avoid wild camping, but you should also consider a few other points before planning an overnight stay away from civilization. It is ideal if you cannot be seen in the first

Underway



Figure 107 Dream camp in Chili (underway.ch)

place, i.e. away from the street, if possible in a dead end, or in a spot that is difficult to reach with a normal car, or you deliberately camp near human dwellings after you have agreed with the residents. In many cultures, they are happy to assume responsibility for the guests in

their area as part of the traditional hospitality. It can also make sense to clarify the security situation with the police in the nearest town, or even to have a place suggested by them for the night.

In known to be sensitive regions, you should make it a routine to place the vehicle in such a way that you can drive away immediately in an emergency! This also means that no items of equipment are left outside overnight and that the inside of the vehicle is also tidy.

Risk of flooding

In arid or desert regions, great care must be taken before camping in depressions or dry riverbeds. There can be a risk of flash flooding there, even if there is no cloud in the sky nearby. If you are surprised, there is no escape.



Figure 108 High water; Left in the evening, right next morning (underway.ch)

Underway

In addition you may also have to reckon with a rising water level on rivers, especially when heavy rainfall is on the way.

Preventing Theft

When it comes to theft and burglary, these are mostly opportunistic crimes. On the other hand, you can also take simple precautions without much effort. In general, if possible, you should not carry any valuables such as expensive jewellery, cameras or watches openly with you. Important documents and wallets should be hidden and worn invisibly from the outside. In addition, you should only carry what you really need on the go, including cash, but above all only in small amounts and distributed on your body. In the event of an incident, you can hand over the wallet with some money, but save the other valuables. Under no circumstances should you resist an attack, otherwise the situation could escalate.

To minimize the risk of breaking into the vehicle, two pieces of advice:

- Do not store valuables in the car where they are visible from the outside, darken the windscreen with an insulating mat. Hide all valuables in the vehicle as good as possible by storing them in a safe, or at least in a difficult to access place.
- Park the car in a safe place. It's better to spend some change for a secure parking than to regret it later.

Additional locks, barred windows or alarm systems can be useful, but they can also send out the wrong signal, namely: "With such rigorous security measures, it MUST be worth breaking in to."

Traffic Accident

The first priority is to prevent a traffic accident. Even when local road users are suicidal, it's best to remain defensive and cautious. If an accident should nevertheless occur, it can quickly become uncomfortable even with trifles. One cannot always count on sensible behaviour on the part of those involved and witnesses. If people or animals have been injured, the situation can quickly escalate. In addition, the foreigner is often to blame anyway, even if it is only a matter of blaming

Underway

him to find compensation for their own damage. In any case, the police must be called in if the situation cannot be resolved quickly and amicably. It might even be a legal requirement to involve the police in any case!

Since it often happens that the guilty party to an accident has no or only poor insurance coverage, it will be difficult to get compensation for your own damage. In the case of minor damage and no injuries, an attempt should be made to regulate the consequences of the accident in a non-bureaucratic manner.

If the police appear, you have to hope that they act correctly, or even in favour of the tourist, otherwise the only thing left to do is to contact your own embassy. It makes therefore sense to have the contact options for your own embassy at hand.

So, even a small accident can certainly dampen the pleasure of traveling, therefore it is all the more important to ensure that it doesn't happen in the first place.

Health Risks

On a trip around the world, almost everyone will get a more or less harmless stomach upset at some point. Unfamiliar spices, the hot climate or a lack of hygiene precautions can be the trigger. A few days and maybe some medication help to quickly forget the incident. But hopefully the digestive system will become increasingly robust and you will be affected less often.

Drinking Water

“Drinking water” can be very tricky. It can contain pathogens, which could have serious consequences. Therefore, in many countries it is better to avoid drinking untreated tap water, and only consume bottled water or from the vehicle's own filtered water supply. In restaurants you should make sure that the bottle is actually sold factory-sealed, otherwise, you may get a re-used bottle filled at the tap.

Underway



Figure 109 Drinking water strait from the source (Turkey) (underway.ch)

In countries with natural spring water sources, one often encounters water outlets that are used by locals. These are usually of good quality and ideally suited to replenish drinking water supplies. Of course, quality is never guaranteed, so filtering is still the best insurance

Food Poisoning

Diarrhoea and vomiting are usually harmless and not always preventable. The upset is usually not critical and mostly resolves itself within a short time. In the case of diarrhoea, it is important to drink plenty of fluids to counteract dehydration. Bouillon and lightly sweetened tea are ideal.

When preparing for cooking previously purchased groceries, the [advice earlier](#) should be considered.

If an indigestion lasts longer than three days, or even causes severe symptoms, you must seek medical treatment, because it might indicate acute food poisoning or a serious illness.

Food or drinking water are not always the cause of the symptoms mentioned above. Stress, yes, this may happen too when travelling, or a hot and humid climate can be the cause for sensitive people.

Malaria

If you travel to designated malaria risk regions, you must take the appropriate precautions. This is mainly based on the protection provided by clothing, mosquito netting and insect repellent. Preventive medication is often no longer suggested. A dose of specific relevant medication carried along as a precaution is used in the event of acute symp-

Underway

toms for rapid treatment. Having a quick test kit with you allows detecting Malaria.

Tropical Diseases

In tropical countries, the health risk is significantly increased and one should keep up to date on which vaccinations are useful and which precautionary measures are to be observed. "Exotic" medicines and vaccinations against tropical diseases are often much cheaper and easier to get locally than at home.

Altitude Sickness

When traveling in high mountains, altitude sickness can become a real health risk and can result in death. Classic travel regions, such as the high Andes, the Himalayan region or the Karakorum, are definitely affected. Depending on personal sensitivity, slight symptoms can occur from 2500 m above sea level. Younger people are more affected than older people! A good physical constitution may promote performance at high altitude, but it has been proven that it does not help against altitude sickness.



Figure 110 Camping in the Altiplano, Bolivia, altitude 4150 masl (underway.ch)

Travelling in a vehicle is particularly critical, simply because you can overcome large differences in altitude very quickly. It is not so much the crossing of a high pass that is tricky, but when you spend the night after a steep climb to high altitude. So you should not climb more than 500 metres in altitude between overnight

stays and at best plan acclimatization days after a significant altitude step. If symptoms of altitude sickness occur anyway, the best and quickest countermeasure is the immediate descent of at least 500 meters in altitude. If you are traveling in a region where rapid descent is not possible in an emergency, acclimatization is all the more important.

Underway

The Altiplanos, which are plateaus over 4000 meters above sea level, in the Andes or the Tibetan highlands are typical areas for this problem, because it is impossible to descend.

The disease is generally divided into three stages:

- **Acute mountain sickness (AMS):** Primary symptom is headache plus: tiredness, dizziness, general weakness, nausea with loss of appetite, increased resting heart rate, reduced urge to urinate, sleep disorders
- **High altitude pulmonary Oedema (HAPE):** pronounced loss of performance, acute shortness of breath, dry cough, so-called rales when breathing (caused by water on the lungs), cyanosis (blue discoloration of the lips and mucous membranes due to reduced oxygen content)
- **High altitude cerebral Oedema (HACE):** paralysis, movement disorders, headaches, hallucinations and even coma.

Acute mountain sickness (AMS) will probably be felt by most people, albeit with mild symptoms, when staying at 3500-4000 meters above sea level. As long as they largely settle down after a day, everything is fine. Under no circumstances should you climb further if you have even the slightest symptoms. If these intensify, the immediate descent of at least 500 meters is unavoidable.

If symptoms of HAPE or even HACE appear, you are in a life-threatening situation, and evacuation to lower altitudes as quickly as possible, or drug treatment by a medical specialist, is essential.

Dehydration

Similar to below, and actually a precursor to heat stroke. This can be recognized by the following symptoms:

- Thirst, dry mouth and dry tongue
- Headache
- Lack of concentration
- Tiredness, weakness

Underway

- Dizziness
- Strongly coloured, to dark, urine; decrease in urine volume

The easiest way to "measure" a lack of liquid is by observing the urine (see above), or you pull the skin on the upper side of your hand together with two fingers of the other hand. After letting go, it should not flatten out "doughy", but be elastic, otherwise this is another sign of a lack of liquid.

Since treatment is primarily through fluid intake, it makes far more sense to prevent. The best way is to drink non-icy, and little sweetened, drinks on a regular basis. It does not have to be one of the advertised sports drinks, but normal drinking water, or slightly sweetened herbal tea also works well.

By the way, when the body only loses 2% of its weight due to dehydration, the first symptoms appear. With a body weight of 70 kg, that's only 1.5 !!! From 12% there is an acute risk of shock and coma!

In very severe cases, an intravenous infusion of electrolytes is required immediately!

Heat Stroke

In hot climates there is a risk of heat stroke due to overexposure. It is important to prevent this by protecting yourself from strong sunlight, not doing excessive sporting activities and, above all, drinking a lot.

If, despite all precautions, heat stroke occurs, the symptoms are red- dening of the skin, weakness, vomiting, dizziness and above all a fever of over 40°C. The only thing that helps, is to cool down the body temperature and drink. If the person cannot be given a cool bath or shower, wet towels that are spread over as large an body area as possible and regular change of them will often help. The person should lie down flat and with their legs elevated. The person must be brought to medical treatment and cool environment as soon as possible.

Underway

Risk of Kidnapping

Even if there are regions in which a kidnapping is possible, these areas are often not of tourist interest. Nevertheless, before travelling to certain countries, you should find out about possible risks on the [official websites](#). You have to be aware that anyone who travels to a country, despite an official warning, and gets into trouble, bears the responsibility and costs themselves. On the other hand, it is understandable that authorities tend to issue cautiously worded warnings. You can therefore also consult the latest experiences of other Overlander in the relevant forums and social media.

Currently (2024) countries classified as sensitive are: small regions of Mexico, several countries in North and Central Africa and the Sahel, some countries in the Middle East, as well as Afghanistan and parts of the western Himalayas. Countries involved in war are definitely to be avoided.

Drugs

One or the other might be tempted to get some extra relaxation at the campfire or in a bar. If you are at the time travelling in a region where drugs are easy to obtain and cheap, it would be a small step to take part.

However, one should not allow oneself to be misled by the simple availability, as the penalties can be drastic in most countries. You might even have to reckon with the dumb tourist being lured into a trap and only realizing the consequences too late.

Smuggling drugs across borders is an irresponsible risk. Especially in countries where you don't expect it, the penalties can be extreme, up to the death penalty. However, in a third world country, you would generally prefer not to be involved in a court case and then end up in prison.

Also, don't rely on the fact that as a tourist you can count on special treatment. Ignorance does not protect against punishment!



Sources and Links

Information and Websites

Travel websites and Blogs

Below is a selection from the author...

[Tuck's Truck](#) (EN)

The two Englishmen Julie and Marcus Tuck have been traveling the world in their 4x4 Iveco for several years. In addition to the travel reports, you will also find a lot of helpful information about travel on their English website.

[Terry on Tour](#) (GE)

Deedrah and Valentin travelled from Switzerland through Asia to Australia in a Hyundai Terracan (TERRY). In addition to interesting travel reports, they also document their travel expenses in detail.

[Landcruising Adventure](#) (EN)

The two Dutch Karin-Marijke and Coen have been traveling around the world in their vintage Land Cruiser since 2003. Except for Europe, Australia and Africa, they have covered almost the whole world. Their contributions are of good quality and very extensive. The two are an excellent example of slow travel.

[Swiss Nomads](#) (GE)

Reni and Marcel have been traveling the world in their high-roof Landcruiser for over 10 years. In addition to the countless travel re-

Sources and Links

ports, you will also find valuable hints on the subject of travel on their website.

underway.ch (GE)

The author's website, which contains, among other things, a detailed documentation of the Panamericana route. But many shorter trips around the world are also described in detailed travel reports. In addition, you will also find many hints and tricks on the subject of travel.

Travelling with Children

Strandfamilie.de (GE)

A German family with school-age children wrote a comprehensive article on the subject of school on the go and their experiences with school. Many of the hints and experiences are general to parents traveling with kids.

5Reicherts.com (GE)

The Reicherts also travel with school-age children and share their experiences on their website.

Travelling with Pets

pawsontour.com (GE)

The Swiss Michael and Ursi travelled the Panamericana with their two big dogs and share their experiences

[Overlanding Pets](#)

The Facebook group "Overlanding Pets" offers up-to-date information and specific questions are answered there by other travelers.

Specialist Forums and general Information Sources

Travel Forums

[Panamericana Info Travel Forum](#) (GE)

A collection of links to travel forums, not only for those interested in Panamericana.

Sources and Links

[Overland Sphere Forum \(EN\)](#)

Extensive discussions on all Overland related topics (preparation, gear, vehicle, route, etc.)

Facebook Groups

On Facebook, there is a corresponding group for most popular destinations. In these groups, you can follow what is currently going on in the region on the one hand, and on the other hand, you can of course also ask questions yourself. Just be specific when you ask. Questions like, "I want to do a trip around the world. What are the must see, the best overnight stays and how much does it cost?", are not likely to be answered.

The best way to find out which regions offer specific groups is to search for "overlanding". In addition, there are countless, more or less significant, groups and pages.

Travel Information

[Panamericana Info \(GE\)](#)

Lots of up-to-date information for traveling along the Panamericana. Information on insurance, shipping, security, long-term parking and much more can be found. There is also an extensive collection of links to relevant websites, an ideal source for researching your own Panamericana adventure.

[Wiki Overland \(EN\)](#)

Country related information.

[Overlanding Association \(EN\)](#)

Clear, graphical information for all countries. Information on entry, carnet, travel-related regulations, etc.

[Nomadlist](#)

Detailed information on living costs and opportunities to work as a digital nomad.

Sources and Links

Travelling the Australian Outback

Many areas of the outback, mostly Aboriginal land, require permits to travel legally.

Since the whole thing is organized regionally, obtaining the information and permits is quite time-consuming. Below are some selected sources on the subject:

[Off-Road travel information and navigation](#) (EN)

[General information](#) regarding permits(EN)

[Northern Territory](#) (EN)

Travel Climate

Good source to consider the climate conditions in the travel planning:

[>LINK< \(GE\)](#)

Shipping

[Seabridge Tours](#)

Very competent agency for RoRo shipping of camping vehicles of all sizes and worldwide. Not always the cheapest option, but certainly one of the most reliable and with excellent customer support.

[IVSS](#)

Organizes RoRo and container shipments worldwide. Usually quite cheap and competent. The availability and response time sometimes requires a little patience.

[International Transport & Shipping](#)

Small but committed company in Switzerland with world travel experience. Organizes primarily container shipments on all possible routes, including to/from the front door. One speaks several foreign languages.

[Mafratours](#)

Sources and Links

Offers a variety of routes. Has a cheap insurance available and reacts very quickly and purposefully.

Documents

International Driving Permit

[International Drivers Association](#)

Anyone can obtain an international driver's license from this organization. Probably a bit more expensive than with official authorities, but especially if you don't know where else to get the document or if you absolutely need one on the way.

HAS NOT BEEN TESTED/USED BY THE AUTHOR

Carnet de Passage

The [Touring Club of Switzerland](#) (GE) offers the document not only for members and Swiss, but also for vehicles registered abroad. See the corresponding detailed information on the linked page.

In which countries a CdP is currently required can be seen here. [>LINK<](#)

Travel and Vehicle Insurance

Health and Travel Insurance

[World Nomads](#)

Comprehensive health and travel insurance solutions. Can be taken out and extended en-route. Reduced premiums for couples. Savings even if USA / Canada can be excluded. Also covers high-risk sports (additional option). Be sure to study the insurance conditions as well!

[True Traveller](#)

The Tuck's have had good experiences with True Traveller. You can find your information here: [>LINK<](#) (On the same page you will find additional information on travel and vehicle insurance worldwide)

Sources and Links

The maximum age for insurance is 65. Various modules, including adventure for higher risks, are available. Prices are very dependent on age

[Panamericana Info general information regarding insurances](#)

In addition to a lot of other travel information about the Panamericana, you will also find good information about travel and health insurance on this website.

Liability insurance South and North America

[Panamericana Info Vehicle Insurance North/South America](#)

In addition to a lot of other travel information about the Panamericana, you will also find good information about vehicle insurance on this website.

Collision Damage Waiver Vehicle Insurance

If you travel to the USA, [Thum is one of the few insurance companies to offer coverage via Seabrigetours](#). This is very expensive, but comprehensive insurance is also included. A possible option may be offered by the insurance broker [CEAT](#) in Germany.

Finances

Creditcards

An overview of credit cards with advantages and disadvantages can be found here: [>LINK< \(GE\)](#)

ATTENTION:

It is essential to check whether the offers are also accessible to foreign customers.

Internet and Telephone

[Internet in the camper \(GE\)](#)

A detailed article on the subject of Internet in the camper.

Sources and Links

International SIM-Cards

keepgo.com (EN)

Keepgo offers SIM cards and routers that can be used internationally. Communication is easy and prices are moderate, albeit more expensive than local offerings.

glocalme.com

Similar offer to Keepgo, but also partly cheaper, regional offers

Since such offers are constantly changing and new providers keep appearing, comprehensive internet research is worthwhile.

Airalo.com

Similar offering including e-SIM for global use

Helpful apps

[iOverlander Website](#)

Also available as a free app for Android and Apple. Only limited use offline. Covers the whole world with a focus on South America. You will not only find all kinds of places to stay, but also information about border crossings, insurance, drinking water, gas and much more.

The data is based on entries by travellers and they are also encouraged to share their experiences through feedback.

[Park4Night Website](#)

Also available as a free app for Android and Apple or fully available offline with a paid subscription. Covers the whole world with a focus on Europe. You can find all kinds of places to stay overnight, mostly for campers.

The data is based on entries by travellers and they are also encouraged to share their experiences through feedback.

[Google Maps](#)

Sources and Links

Well, Google Maps should be familiar to everyone, but it has some perhaps less common uses:

For example, we use Google Maps to [document our routes](#) on the website. In addition, we continuously mark places that interest us on Google Maps (sights, special camping facilities, garages, addresses of friends, etc.) and use the information to plan our route. However, the website is clearly better suited for this, as there are many more options than with the corresponding app.

Google Maps is also interesting because it uses its own map database, often an important alternative to other navigation apps which are mostly based on Open Street Map and therefore always show the same map.

The app is available in Android and Apple versions and can be downloaded from the stores.

Mapy.cz

The Mapy app has developed tremendously in recent times. The app is available for Android, Apple as an app and as a website.

The map base for this app is also Open Street Map. The map image is very clear and even contour lines are integrated into the hiking map. The maps can be downloaded by country and are therefore available offline. In online mode, you can also switch to the satellite map.

Navigation with intermediate destinations is possible for vehicles and pedestrians and also offers several variants to choose from. The generated elevation profile of the route is also good. Depending on the region, traffic information is optionally displayed.

You can also record your own journey and your own waypoints can be saved. GPX data can also be imported. If you register with Mapy, personal data is stored and made available regardless of the device. So you can plan on the PC and then use it on your cell phone.

Sources and Links

As already mentioned, the map image with the terrain relief is very clear and the variable level of detail is also excellent.

The app is free and has no annoying ads. Android and Apple version available.

[WeatherPro](#)

When traveling, the weather plays a very important role. WeatherPro we find a really good tool to call up the weather forecast quickly and easily. Various destinations can be saved and called up when required.

Sure, local weather bureaus offer better and more comprehensive forecasts, but they are often difficult to find, inconsistently structured and often only available in the local language. It's usually enough to take a quick look at what the area should look like in the next few days. The app is available in Android and Apple versions and can be downloaded from the stores.

[Easy Currency](#)

Again and again you have to know exchange rates when traveling in order to be able to estimate costs and prices. We use Easy Currency for this. In principle, the app also works offline, but it should also be used online more often so that the courses are kept up to date.

You can save the frequently used currencies as favorites so that they can be used quickly and clearly.

The app is available for Android and Apple

Safety

[UK Foreign Travel Advice](#)

Information platform for UK citizen providing travel advice and warnings.

[US Travel Advice](#)

Equivalent as above for the USA

Sources and Links

Health

[Swiss Tropical and Public Health Institute Basel \(GE\)](#)

Recognized as a competent institute for individual medical advice and vaccinations. They also sell the highly recommended mosquito repellent Mükorex, which is used for spraying on textiles and the interior of vehicles. Water-based and available as a water-dilutable concentrate.

[healthytravel.ch \(GE\)](#)

General information on health when travelling, vaccinations, risks, etc.

[tropeninstitut.de \(GE\)](#)

German private tropical institute

Vehicle Build and Equipment

Tire Monitoring System

[Tiremoni](#)

Retrofit solution for all vehicles. Display of pressure and temperature of all 4 tires. Optical and audio alarm when the pressure drops or falls below the set pressure.

[UV Water Disinfection System in the pipe \(GE\)](#)

The compact UV disinfection system built directly into the water pipe is particularly useful when little space is available.

More information about the equipment of off-road vehicles can be found in the book "Travelling in 4x4" mentioned below.

Modern Diesel Vehicle

Modern diesel vehicles can have some issues with the exhaust system and engine management if the required fuel quality cannot be supplied or when travelling in high altitudes. There are some companies which can modify and adapt such vehicles. E.g.: [>LINK<](#)

Other Books and Games of the Author

Sources and Links

In addition to this "Overlander Handbook", other books and games are available on the author's website: [>LINK<](#)

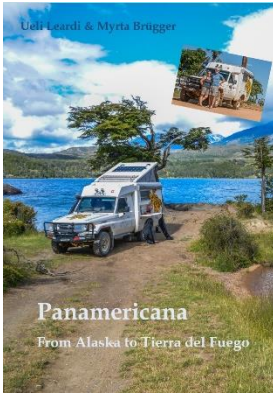

Panamericana

The accumulated adventures and experiences on the more than two-year journey along the Panamericana have been summarized in this book. A simple e-book contains the pure texts, a richly illustrated .pdf version is also available.

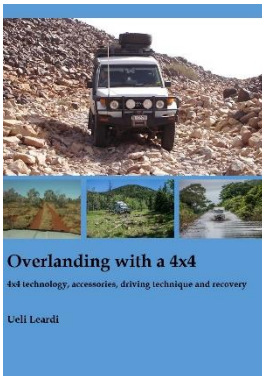

Overlanding with a 4x4

The book is aimed at people who plan to travel in a 4x4 vehicle. The 4x4 technology, accessories and equipment are explained. Assistance is given to move the vehicle safely and competently and to overcome difficulties.



Overlander Game

If you can't go on a big journey yourself yet, you have the opportunity to take a virtual journey with the Overlander Game.

The board game is a «kit» and can be put together yourself after downloading.